

U.S. FISH AND WILDLIFE SERVICE
THE DIVISION OF CONTRACTING & GENERAL SERVICES (CGS)

SPACE MANAGEMENT HANDBOOK

SEPTEMBER 2012

FINAL



This page is intentionally left blank.

TABLE OF CONTENTS

CHAPTER 1 - Introduction.....5
Cost Avoidance.....9
LEED/Energy Star9
Improved Common Areas and Amenities9
Alternative Workforce.....9

CHAPTER 2 – Space Management Coordinators and Warranted Leasing Contracting Officers.....11
Who will use this handbook?13
Regional Space Management Coordinators13
Leasing Contracting Officers with a Service-Issued Warrant13
Purchase Order versus Lease Contract.....13
Warrant Requirements for Leasing Contracting Officers.....13
Classes Required for a Leasing Contracting Officer’s Warrant.....13
GSA’s Contracting Officer Representative (COR)13
FWS Space Management Coordinators Contacts15
FWS Warranted Leasing Contracting Officers Contacts15

CHAPTER 3 – Space Utilization17
What is driving the quest for more efficient space?19

CHAPTER 4 – Design Concept Universal Planning/Integrated Workspace21
Universal Planning.....23
Integrated Workspace.....24
Fixture Selection25

CHAPTER 5 – Space Types27
Office Type Space Descriptions.....29
Special Space Descriptions30
Exempt Space Descriptions.....33
Exterior Space Descriptions.....36

CHAPTER 6 – Guidelines for Space Planning.....39
Office Space Guidelines41
Support & Special Space Guidelines42
Space Typicals42
Conceptual Footprint.....56

CHAPTER 7 – FWS Space Request Procedures	63
Types of Lease Space Acquisition	65
Executive Orders and Regulations	65
Start the Space Process	66
Space Requirements	67
Development of the Program of Requirements.....	67
Methods to Reduce Space Costs	67
Collocation	68
Interagency or Cooperative Agreements	68
Delegation of Leasing Authority	68
 CHAPTER 8 – Space Requirements Calculator	 73
Introducing the New Space Requirements Calculator	75
How to use the Space Requirements Calculator	76
 CHAPTER 9 – GSA Space Leasing Process.....	 81
What can GSA do for the Space Management Coordinator and FWS?	83
Issues Commonly Overlooked During Lease Planning	83
Requesting Space from GSA.....	83
Advertisement.....	84
Market Survey.....	84
Request for Lease Proposal	84
Occupancy Agreements.....	85
Award of the Lease	85
Space Planning (Post-Award).....	87
Construction, Inspection, and Acceptance.....	87
Move	87
Post Occupancy Services Provided by GSA.....	88
Daycare Facilities	88
GSA Regional Account Managers for the DOI/FWS.....	89
 CHAPTER 10 – Lease Administration, Alterations and Reporting	 91
General Lease Administration.....	93
Space Alterations in GSA Controlled Space.....	93
Space Alteration Guidelines.....	94
Vacant Premises Adjustment.....	95
Lease Termination – Moving Out.....	95
Leased Space Reporting Requirements	96
 CHAPTER 11 – Occupancy Agreement	 97
Occupancy Agreement for GSA Controlled Space	99
Occupancy Agreement Termination Rights	99

CHAPTER 12 – GSA Rent Bills and Lease Costs	101
FBMS.....	103
GSA Rent Bills Online.....	103
GSA Rent Bill.....	103
Shell Rent.....	104
Amortized Tenant Improvements.....	104
Operating Costs.....	105
Real Estate Taxes.....	105
Overtime Services.....	105
Parking.....	105
Rent Charges for Other Space.....	105
Public Buildings Service (PBS) Fee.....	106
Joint Use Space Charges.....	106
Lump Sum Adjustments.....	106
Reimbursable Services.....	106
Antenna Bill.....	106
R/U Factor.....	107
CHAPTER 13 – Department of Homeland Security Costs	109
FBMS.....	111
Security Bill Charges.....	111
Security Requirements.....	111
Security Work Authorization (SWA).....	112
HSPD-12 Cards (a.k.a. Smart Cards).....	112
CHAPTER 14 – Glossary	113
Acronyms.....	115
Definitions.....	119
CHAPTER 15 –Appendix	135

This page is intentionally left blank.

CHAPTER 1
Introduction

This page is intentionally left blank.

In 2012, over 50% of the Fish and Wildlife Service's 10,000 personnel are located in leased space. To provide office space for these individuals, the Service leases over 2,000,000 square feet of office space through 257 separate leases at a total annual cost of \$51 million. Not only is this a major budgetary commitment on the part of the Service, but the quality, configuration and amenities associated with this space have a significant impact on employee work life and job satisfaction.

The purpose of this revision to the Space Management Handbook is to provide the tools to the Service's Space Management Team to enhance general office work environments and to more efficiently and effectively utilize the office space available. The Service is encouraged to adopt this progressive space utilization approach where practicable. It will reduce our leased space footprint, while creating a flexible and adaptable work environment that meets the needs of our multi-generational workforce. This approach helps to avoid future costs, reduce our carbon footprint and bring us more in line with the private sector, while efficiently accommodating an ever increasing alternative workforce. There are several key factors to keep in mind as this new approach is implemented, including the following:

- For the first time the American workforce is made up of four distinct generations:
 - Vets – born prior to 1943. These individuals continue to contribute in the workforce as volunteers, contractors and post-retirement employees.
 - Baby Boomers – born between 1943 and 1961. Although many are approaching retirement, they represent a large percentage of the workforce. This generation has adapted to technology, but was not raised on it.
 - Generation X – born between 1962 and 1977. Technology has always been part of their life. They tend to be autonomous, value flexibility and want a voice in how things are done.
 - Millennials – born between 1978 and 1997. Grew up with technology assimilated into every aspect of their lives. They seek open work communities where knowledge is shared, the pace is rapid and new ideas are openly sought.
- Alternative workers (teleworkers, telecommuters, remote workers, part time workers, flex time workers, job share workers, etc.) are becoming an increasingly large percentage of the workforce.
- Even in the traditional work environment, studies have shown that due to complexity of issues and collaboration demands, many workers today are spending over 40% of their time away from their primary workspace.
- Carbon emissions associated with leased space generate over 10% of the Service's total carbon footprint.
- GSA now requires all new construction for leases over 10,000 square feet to comply with Leadership in Energy and Environmental Design (LEED) Silver standards.
- Leases not remaining in existing buildings and which have over 10,000 square feet must have an Energy Star label at the new location.

- Approximately 75% of the Service's 257 leases will be expiring in the next five years.
- On average, market adjustments will cause an increase of 15% in the lease rate at lease renewal. This will result in a minimum increase of approximately \$5.7 million in space cost.
- The FWS space utilization standard has been adjusted to 180 usable square feet (USF), refer to FWS/CFM/049989 Memorandum from December 2011 in the appendix. This utilization rate will be calculated "all in" including all office space, circulation, conference rooms and special space. Unique space situations may be waived from the calculation such as laboratories, data centers and special requirements storage.

Considering all of these factors, a new approach to the Service's current and future space requirements was developed that will reduce costs, support our carbon reduction and sustainable building goals while meeting the needs of our workforce over the next 15 years. Key elements of this new approach are as follows:

- All new or renewed leases, Service-owned and Service Managed Not Service Owned buildings will meet a space utilization standard of 180 USF or less per person "All-In". The utilization rate is determined by dividing the total usable square feet by the number of personnel housed within the space. This standard of 180 USF includes a predetermined circulation factor.
- Open floor plans will be encouraged. Supervisors can have walled offices, non-supervisors will have workstations. Office/workstation size standards will be planned in compliance with FWS Space Policy and Space Requirements Calculator.
- Currently, many Service locations include mostly private offices with only a few workstations. Application of the proposed standards will create a mix closer to 20% walled offices to 80% workstations. This distribution is more in line with current private sector space utilization allocations.
- Alternative workers who are in the office less than three days per week will be accommodated with alternative workspace. "Hoteling" and "Hot-desking" are two of several options for meeting the needs of the alternative workforce.
- Office furniture and workstation configurations will be developed with a corporate approach for consistency of look and inventory management within a given lease. Storage based furniture or other similarly efficient components may be used to greatly improve space utilization while reducing costs.
- Floor plans will emphasize the location of open plan staff (workstations) on the perimeter window walls with support space on the interior while ensuring strategic placement of walled offices with the appropriate use of glass partitions and transoms to maximize day lighting.
- When new or renovated space is configured, integrated workspace planning will be used to ensure the overall layout and common spaces can accommodate the needs of our multi-generational workforce and the ever increasing percentage of our work being accomplished through teamwork and collaboration.

Some of the specific benefits the Service will achieve through this approach include:

- **Cost Avoidance:** The cost of build-out, furniture and office moves along with the per square foot lease rates all increase over time. The new approach will help to minimize these costs in the following ways:
 - **Reduce Footprint:** As leases expire and the Service moves into new space or renovates existing space, market rate adjustments and the requirement for LEED certified or Energy Star space will increase the cost per square foot of leased space. By reducing the utilization standard from 200 to 180 USF per person, the Service will offset a significant portion of this increase.
 - **Open-plan Design:** Build-out for a private office typically costs two to three times that of a workstation. By housing approximately 80% of employees in workstations the Service can save significant costs.
 - **Storage Based Furniture:** Storage based furniture to support a typical 8'x8' work area is on average 18% less expensive than systems furniture. Storage based furniture uses a relatively small number of component parts which can be configured in multiple ways. This not only reduces the purchase price but greatly reduces the cost to tear down, move and reconfigure the furniture.
 - **Reduce Move Cost:** Intra-office employee moves to accommodate changing organization, mission requirements or meet short term work surges are common occurrences in the Service. Use of universal planning in conjunction with storage based furniture can significantly reduce the cost of inevitable intra-office moves.
- **LEED/Energy Star:** The General Services Administration (GSA) requires that all new construction lease projects over 10,000 square feet comply with LEED Silver standards. Additionally, if a Federal agency is moving to a new building and is leasing over 10,000 square feet, the new building must have an Energy Star label in the most recent year. An open floor plan which supports adequate air circulation, efficient heating and cooling and enhances day lighting supports both LEED and Energy Star requirements. Additionally, carbon emissions from our utilization of leased space are the third largest component of the Service's carbon footprint. Reducing the amount of leased space while improving energy efficiency strongly supports the Service's carbon reduction goals.
- **Improved Common Areas and Amenities:** Combining integrated workspace planning with an open floor plan concept creates opportunities for enhanced common areas and amenities. The efficient layout of office space and the thoughtful design of common areas will ensure that adequate team rooms, workspace, and quiet areas are provided to promote collaboration, minimize distractions and balance the need for privacy with interaction.
- **Alternative Workforce:** To compete with private industry and other government agencies for the future worker, the Service must clearly demonstrate its ability to seamlessly integrate the alternative worker into our workforce and office space. As this workforce grows in the future, the Service will need to continue adapting and modifying its workspace. The integrated workspace planning, open floor plan and storage based furniture all support a workplace that can readily adapt to changing needs.

When implemented, the approach outlined above will be a cultural shift for many Service employees. Experience has shown, however, that after an initial adjustment period and the adoption of some common sense etiquette, employees appreciate the openness, daylight and collaboration that a well-planned and open workspace creates. In addition, this approach highlights the Service as a progressive, forward-thinking organization when it comes to the efficient use of limited funding, minimizing our carbon footprint and strongly supporting the quality of our employees' work life.

CHAPTER 2
Space Management Coordinators And
Warranted Leasing Contracting Officers

This page is intentionally left blank.

Space Management Coordinators and Warranted Leasing Contracting Officers

Who will use this handbook?

The Space Management Handbook is provided to assist the Space Management Coordinators and Warranted Leasing Contracting Officers (LCO) in the preparation of accurate space requests and to ensure proper leasing procedures are followed. Space Management personnel must adhere to the following requirements:

Regional Space Management Coordinators

- The Space Management Coordinators are the primary contacts on leasing; provide advice, guidance, etc. on day-to-day lease matters.

Leasing Contracting Officers with a Service-Issued Warrant

- FWS Warranted Leasing Contracting Officers may authorize GSA Occupancy Agreements (with concurrence from the Chief, CGS) and execute leases within their Delegation of Authority limits.

Purchase Order versus Lease Contract

- To acquire space, a Warranted Leasing Contracting Officer must use a lease form (SF-2 or GSA Form 3626)—not a Purchase Order.

Warrant Requirements for Leasing Contracting Officers

- The Leasing Contracting Officer must meet the requirements for a warrant as stated in the Department of the Interior, Contracting Officers Certificate of Appointment Manual. The warrant is issued in writing by Washington Office, Contracting and General Services (CGS) on a case-by-case basis. The warrant is issued to the person, not the position. Because the Federal Government is structured by a system of delegated powers, the authority transferred to line Contracting Officers is limited and specific. Leasing Contracting Officers continuing education requirement is 40 hours every 2 years.

Classes Required for a Leasing Contracting Officer's Warrant

- The following classes are required for a Leasing Contracting Officer's Warrant:
 - Federal Real Property Leasing or Basic Lease Contracting.
 - Techniques of Negotiating Federal Real Property Leases.
 - Cost and Price Analysis of Leasing Proposals.
 - Real Estate Lease Law or Federal Real Property Lease Law.
 - Real Estate Appraisal Principles.

GSA's Contracting Officer Representative (COR)

- The COR serves as the on-site representative for the GSA Contracting Officer. An important purpose of the COR program is to establish one person on site as the main contact of the Lessor. The GSAR states that "COR means a Government employee designated in writing by

the Contracting Officer, by name and position title, who is authorized to take action for the Contracting Officer within specified limitations. A Contracting Officer may not authorize a COR to issue change orders or otherwise modify a contract unless the COR is a warranted Contracting Officer." The responsibilities of the COR will be to:

- Represent the FWS as a liaison between the Contracting Officer and the Lessor or the designated representative.
- Have a working knowledge of the lease as it pertains to the day-to-day operations of the leased space.
- Monitor and inspect for the Lessor's compliance with the lease as it pertains to the delivery of services, utilities, and maintenance.
- Investigate complaints, determine validity and if necessary resolve complaints.
- Communicate with the Lessor or the designated representative, when necessary, in order to achieve compliance with the lease.
- Maintain up-to-date and accurate lease enforcement files, including documentation of all oral communications with the Lessor, copies of letters, and copies of inspection reports.
- Inform the Contracting Officer when the Lessor has not responded to efforts to make him/her/them comply with the terms of the lease.
- Know what to do in emergencies as they relate to the safety and well-being of FWS employees and property in the leased space.
- Be familiar with fire and life safety requirements in the lease. Report suspected deficiencies to the Contracting Officer and/or the Lessor. Use a common-sense approach to identify hazards and follow up to ensure correction.
- Perform various other lease management and enforcement duties at the direction of the Contracting Officer or management.

The COR appointment is made to the person, not the position. The Department of the Interior requires that each COR attend 40 hours of training every two years.

- GSA also has a COR program which is administered by the GSA Regional Real Estate Division in whatever Region the lease space is located. If GSA does not have a GSA building manager who serves as the COR, GSA requests that a COR nominee be submitted to GSA. GSA makes the request for a COR nominee from the largest tenant agency (lead agency) housed under the specific GSA lease. GSA then sends out a COR tutorial and after successful completion of the COR test, the appointment is made by GSA. GSA does not compensate the agency in any way for performing COR duties for the GSA awarded lease.

FWS Space Management Coordinators Contacts

Region	Covers	FWS Space Management Coordinators	
1	Pacific Region ID, OR, WA, HI, other Pacific Islands	Sue Jung 503-231-2036	
2	Southwest Region AZ, NM, TX, OK	Rey Aragon 505-248-6792	
3	Great Lakes/Big Rivers Region MN, IA, MO, WI, IL, MI, IN, OH	Laurie Lewis 612-713-5216	
4	Southeast Region AL, AR, FL, GA, KY, LA, MS, NC, SC, TN, Puerto Rico/Virgin Islands	Wanda Purdy 404-679-4096	Cameron Matthews 404-679-7109
5	Northeast Region CT, NH, VT, DE, NY, VA, ME, NJ, WV, MD, PA, MA, RI	Jeff Parsons (acting) 413-253-8241	Lisa Virgilio 413-253-8243 Mary Smith 413-253-8234
6	Mountain/Prairie Region MT, WY, UT, CO, ND, SD, KS, NE	Cathey Willis 303-236-4325	
7	Alaska Region AK	Eric Mead 907-786-3818	
8	California/Nevada Region	Brad Helm 503-231-6740	
Washington Office	General Services and Policy Branch, Washington Office, D.C.	Veronica Ahmad 703-358-1843	Peter Langer 703-358-2242

FWS Warranted Leasing Contracting Officers Contacts

- The FWS Warranted Leasing Contracting Officers are listed as follows:
 - Peter Langer (Washington Office) 703-358-2242
 - Sue Jung (Region 1) 503-231-2036
 - Laurie Lewis (Region 3) 612-713-5216
 - Ginny Geehan (Region 8) 503-736-4786

This page is intentionally left blank.

CHAPTER 3
Space Utilization

This page is intentionally left blank.

Space Utilization

What is driving the quest for more efficient space?

In a memo issued on June 10, 2010, from the President to heads of Executive Departments and Agencies, we were directed to accelerate efforts to identify and eliminate excess properties and take immediate steps to make better use of space by increasing occupancy rates.

- It is the Service's objective to acquire sustainable facilities with efficient occupiable office space to house all staff. Facilities must accommodate personnel in configurations ideally suited to the performance of each Program's mission while staying within the FWS mandated utilization standard of 180 usable square feet (USF) per person. With the implementation of the new space guidelines, the Service is able to comply.
- FWS requires that the maximum utilization rate be 180 USF or less when acquiring new or additional leased space, or when planning office space in owned facilities. The 180 USF per person should be measured using ANSI/BOMA standards and will include all individual and shared space such as private offices, workstations, circulation, general office filing and storage space, and meeting rooms. This is what we call an "all-in" approach. (See 370 FW 2 and the FWS Space Utilization Memorandum in the Appendix).

Note: Exclusions may include special support space such as: Libraries, Data Centers, Laboratories, Warehouse Space and Special Requirement Storage.

- Utilization rates are calculated by determining the total usable area, subtracting the amount of exempt special support space, then dividing by the total number of planned occupants.
- The Space Requirements Calculator will automatically calculate the utilization rate. The total number of planned occupants results from the manually input portion of the calculator titled "Headcount Summary". The occupants are determined by the approved organizational chart. The total number of offices/workstations does not necessarily equal the number of approved occupants on the organizational chart.
- For example, if there is an office or workstation assigned for every person on the organization chart, and an additional hoteling station for visitors is planned, the hoteling workstation does not count as an occupant. The area of that workstation is shared among all of the occupants resulting in a higher utilization rate. On the other hand, if there are fewer workstations than number of occupants (four staff share two workstations) the utilization rate will be lower.
- Prospectus leases require a space utilization of 130 USF per person excluding circulation. The circulation factor is limited to 22% for prospectus leases. To qualify as a prospectus lease the FY12 annual lease cost must be \$2.79 million or more. This is a unique situation within the Fish & Wildlife Service. To assist with the prospectus lease space requirements a modified Space Calculator has been provided in the Appendix.

This page is intentionally left blank.

CHAPTER 4
Design Concept
Universal Planning / Integrated Workspace

This page is intentionally left blank

Design Concept Universal Planning/Integrated Workspace

Universal Planning

Universal planning is a one-size-fits-all approach to space planning for the Integrated Workforce that involves moving the staff, not the actual office. Offices and workstations are available in a few standard or typical layouts using comparable furnishings (kit-of-parts). Inventory management of furnishings is made considerably easier. Employees are able to select from management approved options and accessories giving them the ability to personalize their environment. Parameters for personalization must be established at the onset. Establishing rules of etiquette and conduct is vital to the overall morale of the group. This type of planning absorbs change within the workforce without having to reconfigure entire clusters of workstations.

Using the aforementioned kit-of-parts, universal planning has been found to reduce occupancy costs on many levels. A box move typically averages \$152 per employee whereas a traditional office move can run \$679 per employee. Add to this the cost of cabling changes and electrical additions and you have added another \$600 to \$1,000 to your original \$679 investment. Churn within the workplace will always exist yet a few tactics are available to help combat the rising costs associated with churn. Those tactics can be included in the universal planning method.

- Demountable Partitions - allows for the re-use of walls being moved.
- Moveable Walls - allows rooms to be multifunctional.
- Raised Floors - allows quick relocation of data, power and telecom.
- Zone Distribution - the use of fiber optic cable from the main telecom closet to a distribution hub.
- Wireless Local Area Network (WLAN) - eliminates the need to rewire every time a computer is relocated.
- Voice over Internet Protocol (VoIP) - eliminates the need to run new phone cable every time a phone is moved.

In 2008 the International Facilities Management Association (IFMA) determined the average cost of providing a private office to be \$6,500 per employee. It was also determined that a savings of \$3,700 per employee could be obtained by applying the open-plan design concepts associated with Integrated Workspace planning. The shift away from individual work conducted by a workforce ensconced in aisle after aisle of private offices has given way to team-oriented, collaborative work. These innovative methods to open office design encourage communication, learning by observation, mentoring and internalization of culture. The multi-generation workforce is offered the opportunity to come together on a level playing field and assist one another rather than hiding behind four walls and a door.

Integrated Workspace

Integrated Workspace planning embraces a straight forward approach to office design incorporating a few simple concepts.

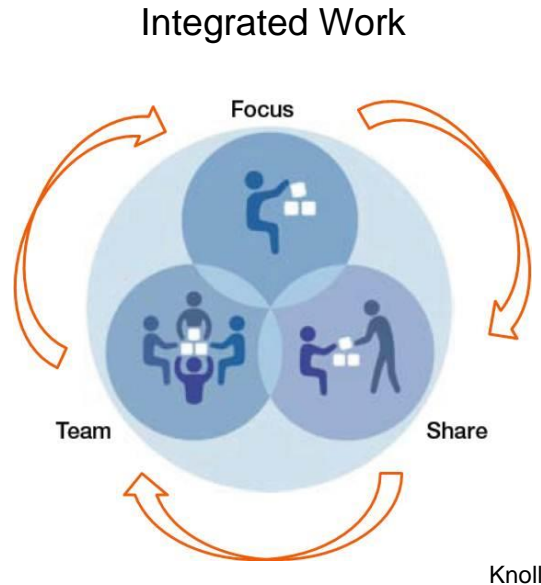

- Design proportionally to the appropriate work activity zones - Focus, Share and Team.
- Integrate collaboration zones through the use of lower horizons for visual access and extended site lines.
- Allow for fluid movement between individual to group work.
- Private offices strategically placed at the building core not on the perimeter window walls.
- The use of a well selected grouping of product elements, known as a kit-of-parts, supports the full range of work modes, easily and economically. These components are designed to allow for air flow and light dispersion both above and below the configuration.
- Contiguous space without demising walls accommodates churn by creating flexible boundaries.
- Use of flexible technology to support the various work locations.

Additional benefits associated with Universal Planning/Integrated Workspace Planning lend themselves to LEED compliance and objectives in GSA projects:

- Reduced operational utility costs.
- Increased useful life of building systems and or equipment.
- Increased property value.
- Increased user satisfaction.
- Reduced global environmental impact.

These goals can be achieved with the incorporation of several energy saving measures such as the use of Energy Star certified equipment, sensor controlled/motorized shades to control and capture heat, power down circuits linked to occupancy sensors, high efficiency lighting fixtures, occupancy sensors, light sensors, dimming & task lighting. Such measures are commonly referred to as “Smart Building Controls”.

Fixture Selection

To conceive of and plan for a truly collaborative/integrated workplace requires a new and unique tool for office space planning. This new category of office furnishings offers an endless array of planning options and aesthetic opportunities with just a few select components in your kit-of-parts. The functional simplicity of storage based planning lends itself to this effort. The interaction between people and technology becomes second nature when systems panels are no longer required to hang components and the power integration takes place inside the units at desk height, not at raceway level.

Storage based componentry serves as an alternative to traditional systems furniture currently in use throughout the Service. Because the storage is integrated into a wall unit which acts as a “partition” between stations, the designer realizes a unique space savings and unusual planning freedom. Highly functional configurations afford ample storage and let in more air and natural light. A more compact space creates an atmosphere of spaciousness, feels bigger and works better.

The same concept for open plan design can be translated to the private office as well. Vast storage needs can be consolidated into a support wall comprised of lateral filing, pedestals, overhead storage units and bookcases. These storage components are combined into work walls used in private offices to maximize the vertical dimension efficiently while reducing the amount of floor space needed.

Storage is a key element to this style of planning as it plays an important role in creating “zones” throughout the workplace when used as a space divider. Freestanding medium height storage walls are used to delineate work groups or team areas while low height storage doubles as standing height work counters. On average, storage-based planning can save 10 percent to 16 percent of floor space when compared to the current panel-based systems furniture workstation. The reduction in floor space does not greatly reduce the work surface area and storage capacity as shown below.

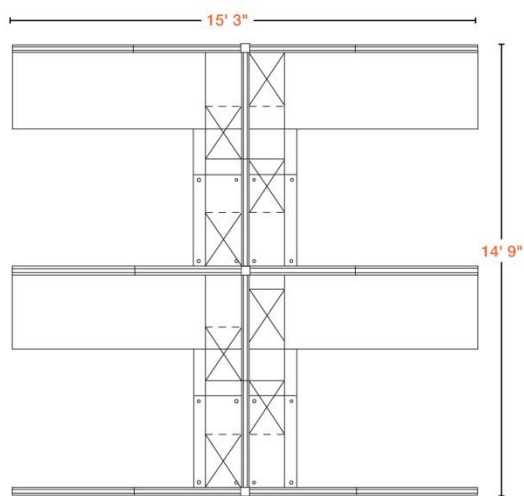

Figure 3
Panel Based Systems Furniture (225 SF)

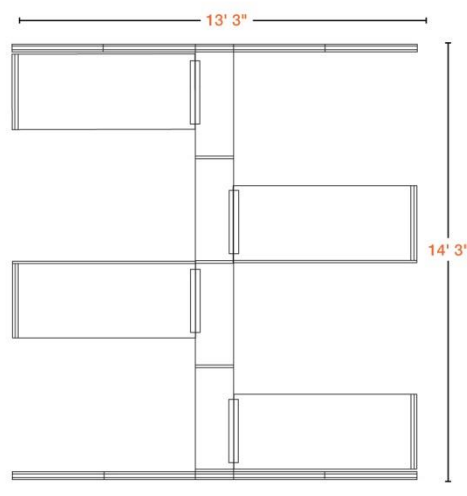

Figure 4
Storage Based Planning (189 SF)
Knoll

The panel based system in Figure 3 has a 225 SF footprint whereas the storage based layout in Figure 4 comes in at 189 SF for a 16 percent space savings. This is accomplished with the use of the shared spine storage wall.

In summary there are three primary benefits associated with using storage based planning system:

- **Efficient Use of Space** - Space within the station is so efficient, a more compact office actually feels bigger. Space savings can be reallocated to collaborative teaming areas or seen as a reduction in leased space.
- **Ergonomics** - Consolidated storage creates improved accessibility and with no fixed pedestals below the work surface it provides more leg room. The lowered horizon allows for more natural light within the office space.
- **Storage Options** - A common complaint among FWS employees is a lack of personal storage space. Stations are built upon storage walls in a variety of configurations giving employees access to storage at their fingertips.

The following office/workstation/support typicals are representational of generic layouts only. Upon selection of a specific furniture manufacturer, detailed and itemized workstation specifications can be finalized.

CHAPTER 5
Space Types

This page is intentionally left blank.

Space Types

Office Type Space Descriptions

Included in the 180 Usable Square Feet Utilization Requirements

Note: All space planning must comply with federal lease requirements outlined in the General Services Administration, Solicitation of Offers and National or Local Building Codes.

- **Open Office:** Open office space planning concepts are preferred in all FWS space. This type of design utilizes systems furniture and reserves window and exterior space for the majority of employees housed. Private offices should be limited along exterior window walls. As much as possible, the interior space should be designed for private offices, conference and team rooms; circulation; copier; kitchenettes; storage and filing. Open office space should be provided with carpeting, fluorescent lighting, standard electrical/phone and information technology outlets, and finished with paint. Refer to Federal Management Regulations 102-74 for guidance on federal facility-related standards.
- **Private Offices:** The use of private offices is kept at a minimum (e.g., supervisors and managers) and workstations are assigned to non-supervisory staff. Private offices should be constructed with ceiling high partitioning, and finished with carpeting, paint, fluorescent lighting, standard electrical/phone and information technology outlets. Refer to Federal Management Regulations 102-74 for guidance on federal facility-related standards.
- **Office Support Space:** Support space is considered office type space for open filing, open meeting areas, reception/seating areas, display space, printer/fax stations, team mailboxes, etc. Support space can also include any rooms that are not offices and do not have above building standard upgrades such as coat and supply closets, storage/file rooms and small meeting rooms, etc.
- **Circulation:** Internal Circulation space is the cumulative amount of aisles and paths of travel within the suite which allows access to offices, workstations and other rooms. Circulation will be calculated at 22% for prospectus leases, 35% default setting, or an optional 40%. Select from pull down in the calculator.

Note: External Circulation space is comprised of the building support corridors as provided by the building to gain access to the suite. This space is not calculated as part of the usable square feet, but is included in the rentable calculation.

Special Support Space Descriptions

- **Conference/Training Rooms:** Conference rooms should be provided based on normal usage with a size and capacity range determined by local code for occupancy and egress purposes, e.g., the approximate square feet per person minimum requirements could vary. Sizing conference rooms should not be influenced by the community need for a gathering or meeting place only once or twice a year. Special requirements may include:

- Slab-to-Slab Sound Transmission Coefficient (STC) 50 sound conditioned partitions.
- Separately zoned and independent HVAC system (for larger conference rooms). This requirement must be evaluated on a case-by-case basis considering the existing building systems, approved capacity of the room and code requirements.
- Room should be free of columns.
- Carpet is standard flooring for this type of area.
- Number and means of egress must be evaluated and based on code requirements.
- Separate lighting zones may be needed based on code requirements.
- Moveable acoustical partitioning, STC 44 - Stored in wall pocket(s). Area above movable partitioning must be partitioned to the structure above and sound conditioned, STC 50.
- Standard or special electrical and data requirements.
- Electric projection screen and/or window shades.
- Audiovisual enhancements.
- Storage area.
- Refer to Federal Management Regulations 102-74 for guidance on federal facility-related standards.



- **Employee Break Room/Kitchenette:** Special requirements may include:

- Slab-to-Slab STC 50 sound conditioned partitions.
- Overhead and base cabinet(s); countertop(s).
- Sink; faucet with hot and cold water and shut off valves; insta-hot; and a garbage disposal.
- Microwave(s) and Refrigerator(s).
- Manually switched exhaust fan, (size and capacity will vary based on size of kitchenette).
- GFI electrical outlets above the countertop area and in the walls for vending machines, and refrigerator(s); and electrical circuits for garbage disposal and insta-hot as needed.
- Resilient floor is standard for this type of area such as Ceramic or Vinyl Composition Floor Tile (VCT).
- Seating area may be included.



Refer to Federal Management Regulations 102-74 for guidance on federal facility-related standards.

Note: All kitchen appliances must be located in approved break rooms.

Mail/Copy/Supply Room: Combine use of these types of rooms whenever possible. Special requirements may include:

- Slab-to-Slab STC 50 sound conditioned partitions are required if the room is equipped with a copy machine.
- The amount of BTUs produced per hour by the copy machine must be quantified and specified in the requirements package for HVAC design considerations.
- A dedicated electrical circuit for the copy machine.
- Separately keyed and/or special locking hardware.
- Security equipment and personnel considerations for mail screening.
- Resilient floor such as VCT is standard for this type of area.
- Refer to Federal Management Regulations 102-74 for guidance on federal facility-related standards.



- **Library/Map Space:** This type of space is to be kept to a minimum. Library or other special space (such as map rooms) is only considered if the stored information is not readily available in electronic format or single use copy for shared use.
 - Be sure to account for a greater need for stronger floor loading. Engineering certification may be required.
 - This space must be constructed for its intended and specific use.
 - Refer to Federal Management Regulations 102-74 for guidance on federal facility-related standards.



- **Storage Room:** Special requirements may include:
 - Slab-to-Slab partitioning.
 - Be sure to account for a greater need for stronger floor loading. Engineering certification for weight-loading may be required.
 - Separately keyed and /or special locking hardware/security system.
 - Speed Filing Systems and/or other Filing Space Savers.
 - Fluorescent lighting.
 - Resilient floor is standard for this type of area.
 - Refer to Federal Management Regulations 102-74 for guidance on federal facility-related standards.



- **Health and Wellness – Shower Rooms/Fitness Facilities:** Special requirements may include:
 - Slab-to-Slab STC 50 sound conditioned partitions.
 - Shower Rooms (women and men's) must be designed based on the size of the facility and anticipated usage, and must meet national building code and/or SFO requirements for numbers of lavatories, toilets, showers and accessibility standards.
 - Lockers, full- or half-length.
 - A bench located within the locker area.
 - Other accessories, including, but not limited to: mirrors; toilet paper, paper towel, soap, toilet seat-cover and sanitary napkin dispensers; trash receptacles; and, hand/hair dryers.
 - Resilient ceramic tile floor is standard for this type of area.
 - Refer to Federal Management Regulations 102-74 for guidance on federal facility-related standards.



- **Storage Room – provided in unoccupied space:** Any room used for storage, usually in the basement or attic, which is considered “unfinished” space.
 - Lower than building standard finishes for ceiling, wall and floor
 - Lower lighting levels than building standard
 - Lower HVAC levels than occupied building standard

Exempt Space Descriptions

Exclusions to the 180 Usable Square Feet Utilization Requirements. This space is in support of the mission of the Service and is excluded from the calculation for utilization standards.

- **Laboratory Space:** Special requirements may include:
 - Slab-to-Slab STC 45, one-hour fire rated partitioning.
 - Finish with sealed concrete flooring OR chemically resistant vinyl tile, base cove, and paint.
 - A floor drain may be required within the room – EPA standards must be met.
 - Filtration systems for laboratory waste that goes into sanitation system. Is it environmentally hazardous? If yes, provide offerors with a list of chemicals that will be used and amounts dispensed weekly.
 - Heating, ventilation and air conditioning is to be provided to office standards.
 - Exhaust fan (determine and state CFM, fan speed and switching requirements) directly vented outside.
 - Chemically resistant base cabinet, sink, and countertop.
 - Eyewash station and an emergency shower with audible and visual alarms.
 - Refer to Federal Management Regulations 102-74 for guidance on federal facility-related standards.



- **Data Center/Server Room and Telecom/Network/Mechanical Closet:** Special requirements may include:
 - Slab-to-Slab STC 50 sound conditioned partitions.
 - Supplemental HVAC to maintain a minimum of 65 degrees and maximum of 72 degrees Fahrenheit temperature range, 24 hours a day, 7 days a week. The amount of BTUs produced per hour by all equipment must be quantified and specified in order to insure proper HVAC requirements.
 - Automated emergency monitoring and notification system.
 - Separately keyed and/or special locking hardware; or electronic keycard access.
 - Special electrical requirements may include: Uninterruptible Power Supply (UPS); Power Distribution Units (PDU); emergency power shut-off; emergency lighting; and a generator for back-up power.
 - Expanded life-safety and fire suppression systems.
 - The 3/4 inch finished noncombustible plywood board for telephone punchboard.
 - Static free raised tile floor is standard for this type of area.
 - Refer to Federal Management Regulations 102-74 for guidance on federal facility-related standards.

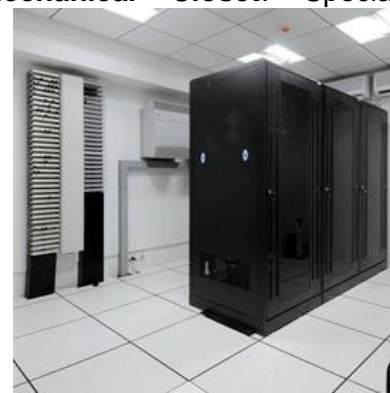

- **Special Storage:** Any room used for storage of unusual equipment (such as heavy equipment or fish tanks) the size of which will cause the organization to exceed the goal utilization rate. May be housed in an unfinished space such as a garage-type setting, or may be in an above building standard space with special plumbing and HVAC.



- **Evidence Room/Weapons Secure Storage:** Special requirements may include:
 - Slab-to-Slab STC 45 sound conditioned and fire-rated partitions.
 - Fire rated solid core door.
 - Separately keyed and/or special locking hardware
 - Wire mesh (9-gauge) installed in walls and over the ceiling in this room or hard-cap the ceiling with drywall.
 - Hard-surface floor such as finished concrete or VCT.
 - Security and/or access control system.
 - Refer to Federal Management Regulations 102-74 for guidance on federal facility-related standards.



- **Exhibit / Display Space:** Special requirements may include:
 - The Service has a priority outreach initiative with exhibits and pamphlets that are displayed in a lobby area and require extra space. Many priority outreach programs use exhibits to partner with or inform the public and visitors of the Service's mission. The exhibits are often displayed in rotation and require storage when they are not showcased.
 - Museum or art gallery type architectural features with specialty lighting, ceiling features, electrical requirements, and possibly temporary construction.
 - An enlarged lobby space for displays, computer kiosks or public assembly.



- **Restrooms:** For the majority of our lease space agreements, restroom space is typically included in the “rentable” portion of the lease; therefore, it is not included in our utilization calculation which is derived from the Usable Square Foot (USF) portion of the lease. In those cases where restrooms are part of the USF allocation, or, the restrooms are located in the “administrative” portion of our owned space (the administrative portion of owned space is where we calculate utilization), then the restrooms are considered “exempt” space.



- **Interrogation Room:** Rooms specific to our Law Enforcement operations used to interview or question suspects or witnesses of a crime.



Exterior Space Descriptions

- **Warehouse:** Special requirements may include:
 - Utilized pallet rack storage systems for vertical space efficiency and utilization.
 - Exterior grilles over windows to deter forcible entry.
 - A minimum of 12 feet clear ceiling height is required.
 - Electronically operated sectional overhead door (specify door size). Door is constructed of steel or fiberglass panels of a quality comparable to commercial-grade standards. Door may be at grade level. A locking system must be included in the overhead door assembly.
 - At least one personnel access door is required.
 - Concrete apron must be provided at all personnel and overhead doors. The apron must be door width plus 2 feet at a minimum in front of the door and sloped to drain.
 - Heating system must be capable of maintaining a temperature of 55 degrees Fahrenheit minimum throughout the warehouse space.
 - Sealed concrete flooring is required.
 - Electrical outlets must be installed 44" above the finished floor.
 - Automatic sprinkler protection code compliant.
 - Industrial-type sink with gooseneck-type faucet and hot and cold water.
 - Restrooms (women and men's; or unisex) may be required depending on how large and the type of operation.
 - Refer to Federal Management Regulations 102-74 for guidance on federal facility-related standards.

- **Wareyard:** Special requirements may include:
 - Asphalt pavement or crushed gravel.
 - Wareyard space may be located contiguous to the warehouse.
 - Vehicle gates such as swinging, top rail rolling, or arm type. Gates require a locking collar or 3/8" galvanized steel chain, plus a metal pole to extend into the ground socket at the center of the gate. Gates may be equipped with an electronically controlled access for ingress and egress.
 - One personnel gate (approximately 3' wide) is required.
 - Since the wareyard is secured, ensure that there is a keyless emergency personnel exit from the wareyard area.
 - Fencing must be at least 6' high chain link fence topped with 3 strands of barbed wire at a 45-degree angle outward. Fencing must have a minimum of 9-gauge hot dipped galvanized metal wire.
 - Refer to Federal Management Regulations 102-74 for guidance on federal facility-related standards.



Parking: Accessible employee parking spaces are provided as required by federal accessibility standards or by local code, whichever is most stringent.

- GSA Federal Management Regulations provide the following guidance for Acquisition of Parking: “Agencies having a need for parking must first use available government-controlled owned or leased facilities. Agencies must inquire with GSA regional offices about the availability of government-controlled space. If no suitable government-controlled parking is available from GSA, an agency may use its own procurement authority to acquire parking by service contract.”



Any space not described here, but requiring above building standard construction will be reviewed and approved on a case-by-case basis. Such spaces may include private toilet, auditorium, cafeteria, high security reception room, comfort room and vending spaces.

This page is intentionally left blank

CHAPTER 6
Guidelines For Space Planning

This page is intentionally left blank

Guidelines for Space Planning

Office Space Guidelines

The following office space guidelines have been established according to Fish and Wildlife’s staff responsibilities and functions. Recommendations provided by the furniture industry were taken under advisement and allocations were standardized for consistency. Space sizes were developed to assist the achievement of the utilization factor of 180 USF per employee. The following chart is a summary of office/workstation standards for use throughout FWS primary office space by staff. The second workstation size reflects the optional use of storage based furniture, as described in Chapter 5. Workstation Typicals shown in Chapter 7 illustrate the difference between the systems furniture workstation and the comparable storage based furniture workstation. Numerous furniture manufacturers have embraced the Integrated Workspace concept and developed lines designed to define individual workstations and group work areas.

SPACE STANDARDS/PRIMARY OFFICE			
Title/Position	Space Type	Space Standard	Space Size
Assistant Director; Regional Director	Private Office	O1	240 SF or 200 SF
DAD; DRD; ARD; SAIC	Private Office	O2	180 SF
Supervisory Division/Branch Chief; Project Leader; Supervisory FTE; Non-Supervisory GS15	Private Office	O3	120 SF
Executive Administrative; Reception; Reasonable Accommodation	Open Workstation	W1	80 SF
Non-Supervisory FTE	Open Workstation	W2	64/52 SF
Non-Supervisory FTE	Open Workstation	W3	48/39 SF
Contractor; Hoteling/Hot Desking Station for Teleworker/Visitor	Open Workstation	W4	25/23 SF

Note: In any office or workstation planning the Washington Office or Regions can determine and approve a lesser amount of space.

Support & Special Space Guidelines

The criteria utilized during office/workstation space standards development were also applied to create support space standards for use throughout the Service. Standardized support spaces include the following:

SPACE STANDARDS/SUPPORT		
Space Type	Space Size	Notes
Quiet Room/Focus Booth	49 SF	Accommodates 1
Small Team Room	120 SF	Accommodates 2 – 4
Medium Team Room	180 SF	Accommodates 6 – 8
Small Open Teaming Area	100 SF	Accommodates 2 – 4
Large Open Teaming Area	200 SF	Accommodates 6 – 8
Interact Zone	550 SF	
File Zone	190 SF	

SPACE STANDARDS/SPECIAL		
Space Type	Space Size	Notes
Large Conference/Training Room	1,100 SF	To Seat 50 – 73
Medium Conference/Training Room	400 SF	To Seat 20 – 26
Work Room	200/360/420 SF	

Space Typical

The following drawings (Typicals) and photos demonstrate the applied concepts of Universal Planning, Integrated Workspace and storage based furniture. The office, workstation and support space drawings illustrate the new size guidelines for the appropriate use. Unless noted otherwise, the furniture shown are examples of the storage based product lines available in today's market.

SPECIAL NOTE: THE FOLLOWING LAYOUTS AND PICTURES ARE FOR CONCEPTUAL AND ILLUSTRATION PURPOSES ONLY AND DO NOT REPRESENT A MANDATORY FURNITURE TYPE OR MODEL.

TYPICAL OFFICE TYPE O1 200-240 SF

Title/Position: Assistant Director; Regional Director
(Layout shown is for planning purposes only)

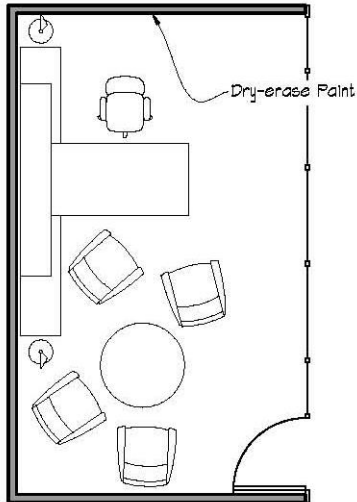

Knoll

TYPICAL OFFICE TYPE O2 180 SF

Title/Position: DAD; DRD; ARD; SAIC
(Layout shown is for planning purposes only)

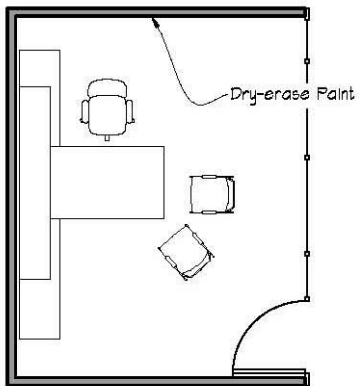

Steelcase

TYPICAL OFFICE TYPE O3 120 SF

Title/Position: Supervisory Division/Branch Chief; Project Leader; Supervisory FTE;

Non-Supervisory GS-15

(Layout shown is for planning purposes only)

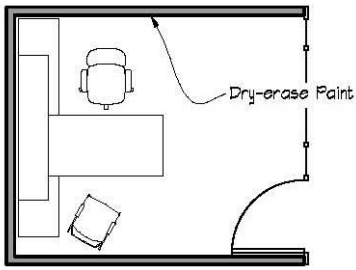

Knoll

TYPICAL WORKSTATION TYPE W1 80 SF

Title/Position: Executive Administrative, Reception, Reasonable Accommodation
(Layout shown is for planning purposes only)

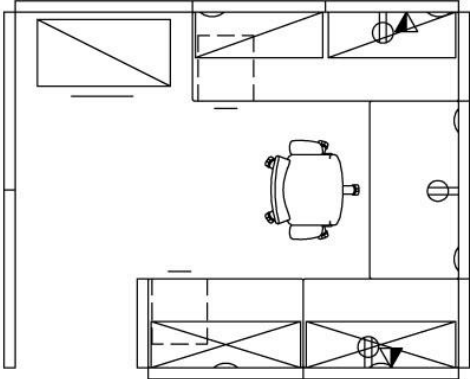

Systems Furniture

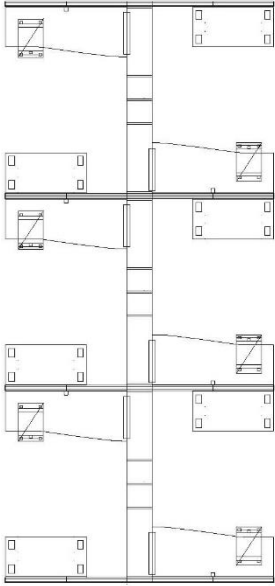

Storage Based Furniture



Knoll

TYPICAL WORKSTATION TYPE W2 64/52 SF
Title/Position: Non-Supervisory FTE
(Layout shown is for planning purposes only)

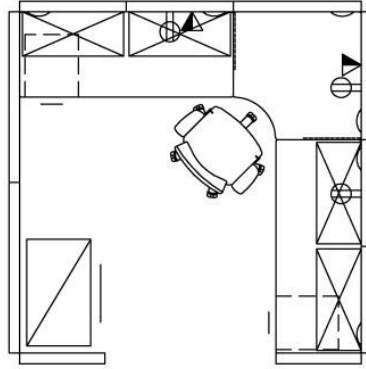

Systems Furniture

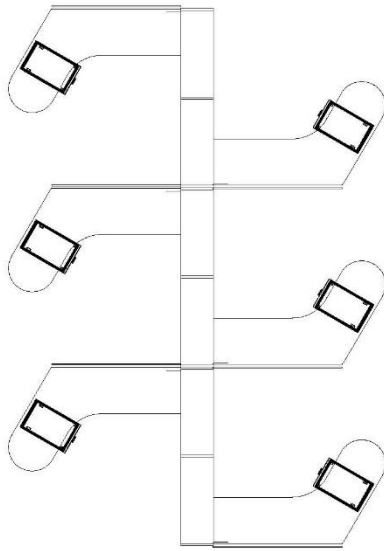

Storage Based Furniture

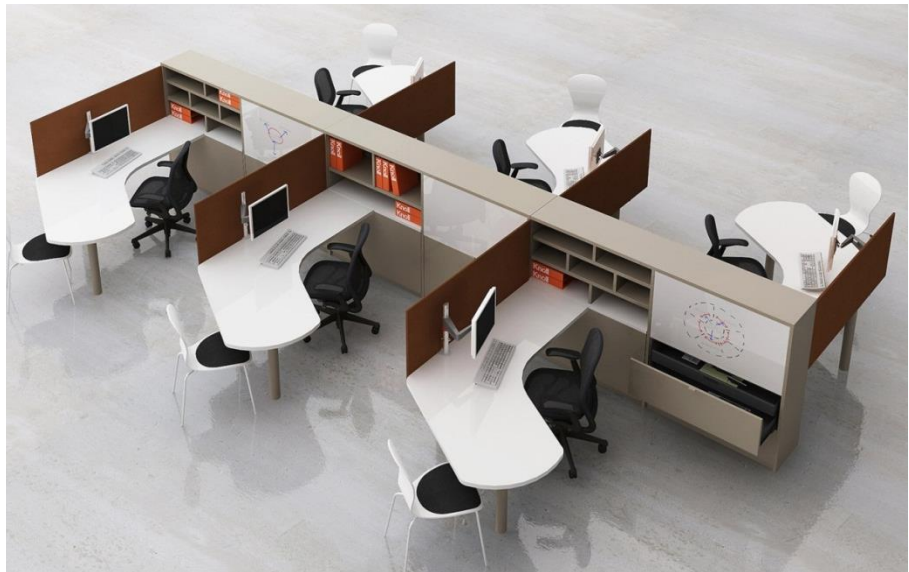

Knoll

TYPICAL WORKSTATION TYPE W3 48/39 SF

Title/Position: Non-Supervisory FTE

(Layout shown is for planning purposes only)

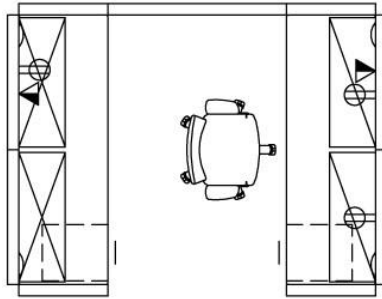

Systems Furniture

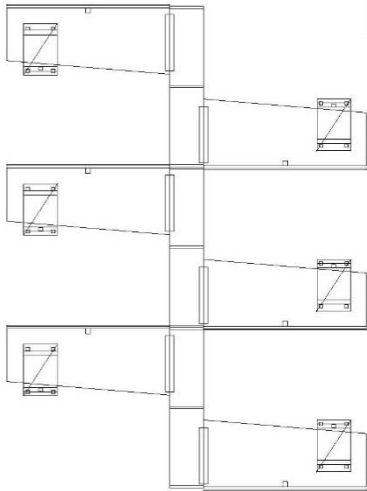

Storage Based Furniture



Knoll

TYPICAL WORKSTATION W4 25/23 SF

Title/Position: Contractor; Hoteling/Hot Desking Station for Teleworker/Visitor.
(Layout shown is for planning purposes only)

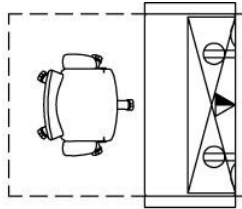

Systems Furniture

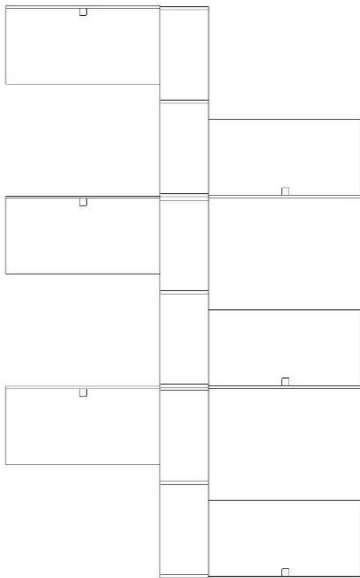

Storage Based Furniture



Knoll

TYPICAL MEDIUM TEAM ROOM (Accommodates 6 - 8) 180 SF

(Layout shown is for planning purposes only)

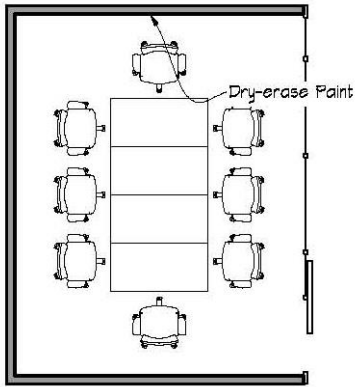

Haworth

TYPICAL SMALL TEAM ROOM (Accommodates 2 - 4) 120 SF

(Layout shown is for planning purposes only)

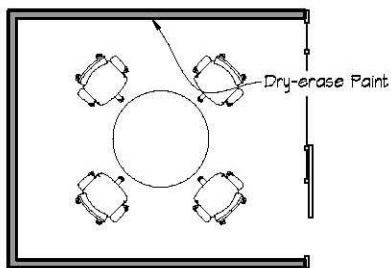

Haworth

TYPICAL QUIET ROOM 49 SF
(Layout shown is for planning purposes only)

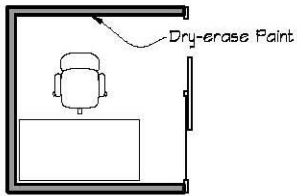

Haworth

TYPICAL SMALL OPEN TEAMING ROOM 100 SF
(Layout shown is for planning purposes only)

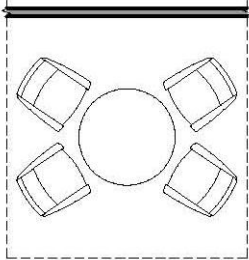

Knoll

TYPICAL LARGE OPEN TEAMING AREA 200 SF
(Layout shown is for planning purposes only)

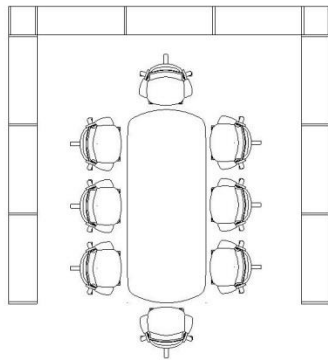

Knoll

TYPICAL INTERACT ZONE 550 SF
(Layout shown is for planning purposes only)

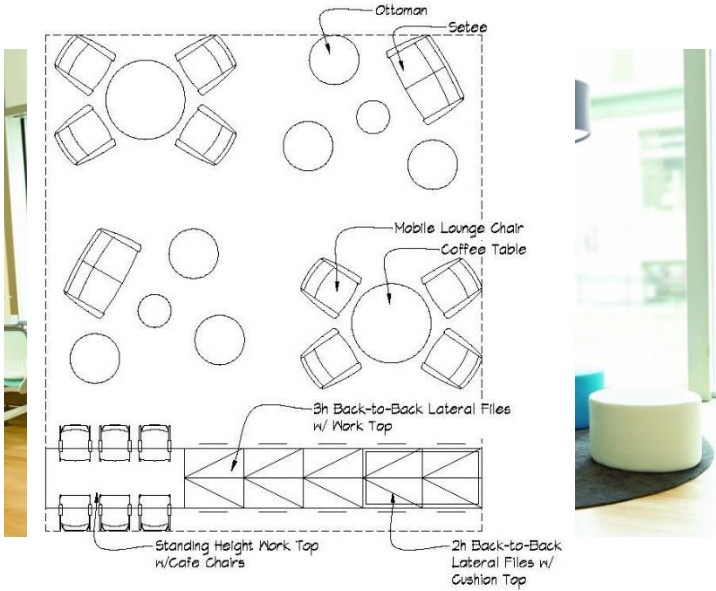

Steelcase

TYPICAL FILE ZONE 190 SF
(Layout shown is for planning purposes only)

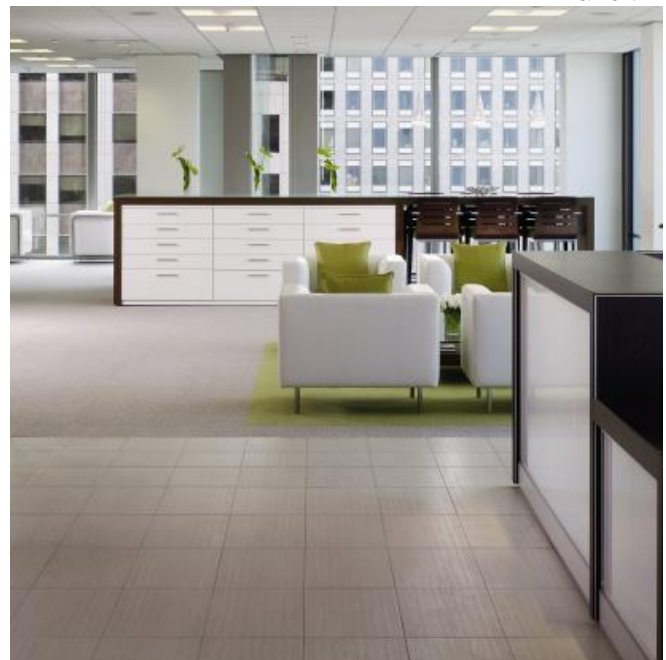
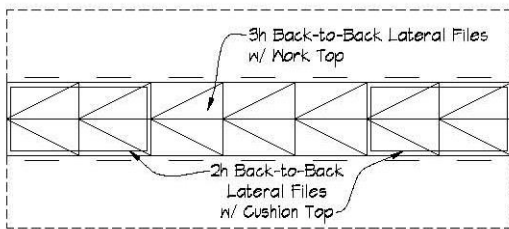

Haworth

TYPICAL LARGE CONFERENCE /TRAINING ROOM
(Accommodates 50 - 73) 1,100 SF
(Layout shown is for planning purposes only)

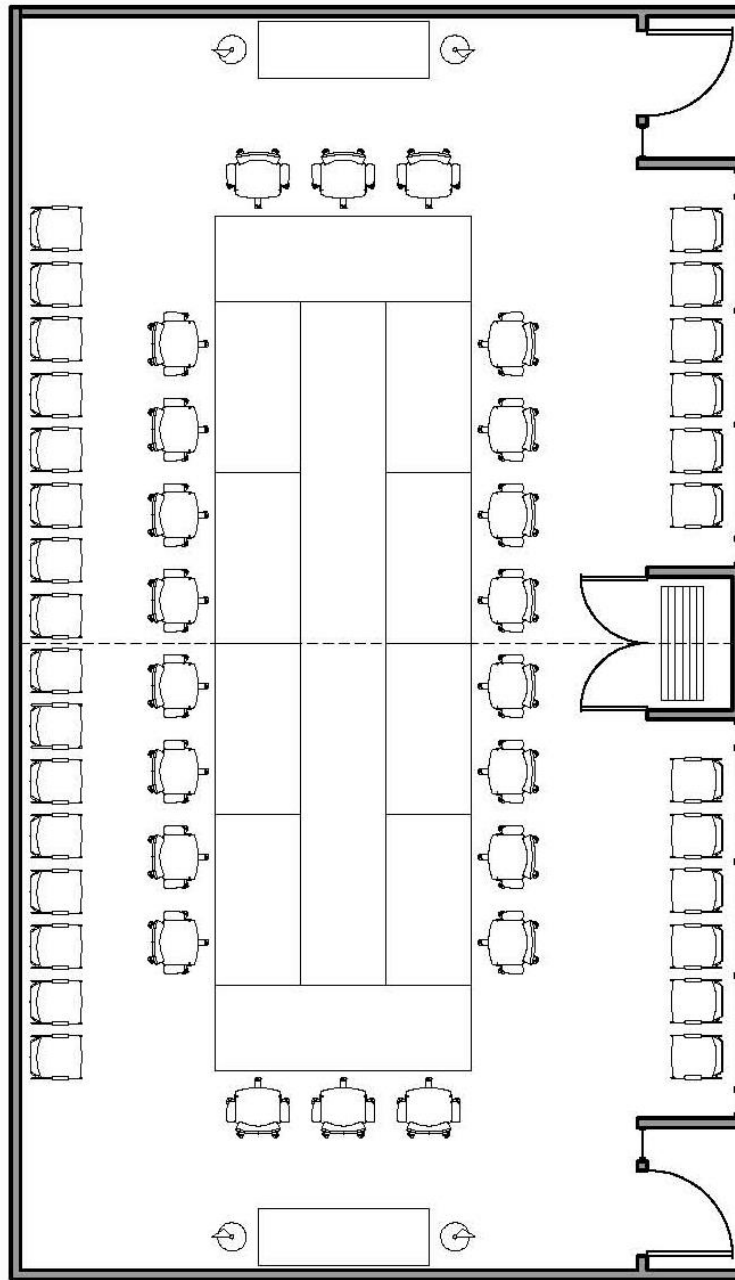

TYPICAL MEDIUM CONFERENCE ROOM (Accommodates 20 - 26) 400 SF
(Layout shown is for planning purposes only)

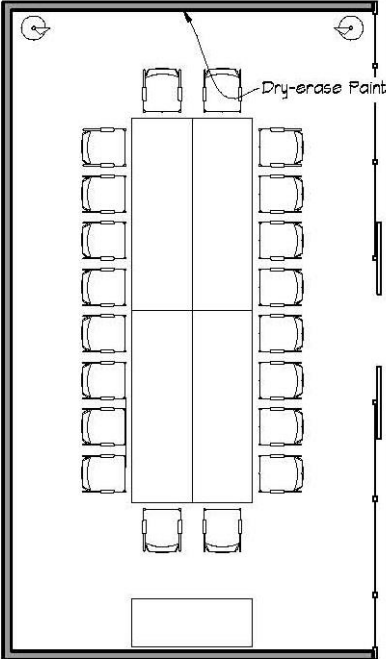

Inscape

TYPICAL WORKROOM 200, 360, OR 420SF
(Layout shown is for planning purposes only)

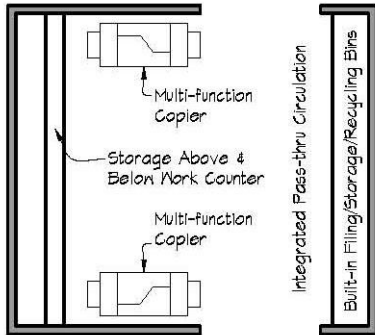

GSA

Conceptual Footprint

U.S. Fish and Wildlife Programs are staffed by a mix of federal employees, contractors and volunteers who are considered experts in their fields. The nature of their work hinges on forming partnerships with Federal, State and local agencies, Tribes, educational institutions, businesses and communities. These experts require space to perform a multitude of tasks ranging from heads-down work to collaborative assignments.

To accommodate the various work style needs a plan is required that will provide for both the primary office worker and the alternative worker. It must encourage and foster collaboration within and amongst Program offices. This concept is achieved by locating primary/alternative office space along with teaming/collaborative areas on specified work floors. The first floor level space would accommodate building amenities such as a secured entrance/security screening/visitor's waiting area; conferencing center; gathering space; free-address space; locker/shower rooms; mail room; loading dock and building support.

The following footprints, Option 1 through 8, represent various possible Integrated Workspace configurations. Primary consideration will be given to locating open plan staff on perimeter window walls with support functions located on the interior. Private offices and meeting rooms will receive glazed demountable partitions at the corridors to promote access to daylight for interior core spaces.

Options 9 through 12 represent various configurations for joint-use and amenity spaces. These functions are normally found at the building entry level. Amenities typically found may include support functions such as:

- A secured entrance
- Conferencing suite
- Gathering space
- Free address space for visitors
- Locker/shower facilities
- Secured mail room
- Building support/loading dock

Following the Conceptual Footprint drawings is an example of a 16,000SF floor plan incorporating the Integrated Workspace concept and the Standard Space Typicals. This is for representational purposes only, space planner must tailor the design on a project by project basis.

Option 1

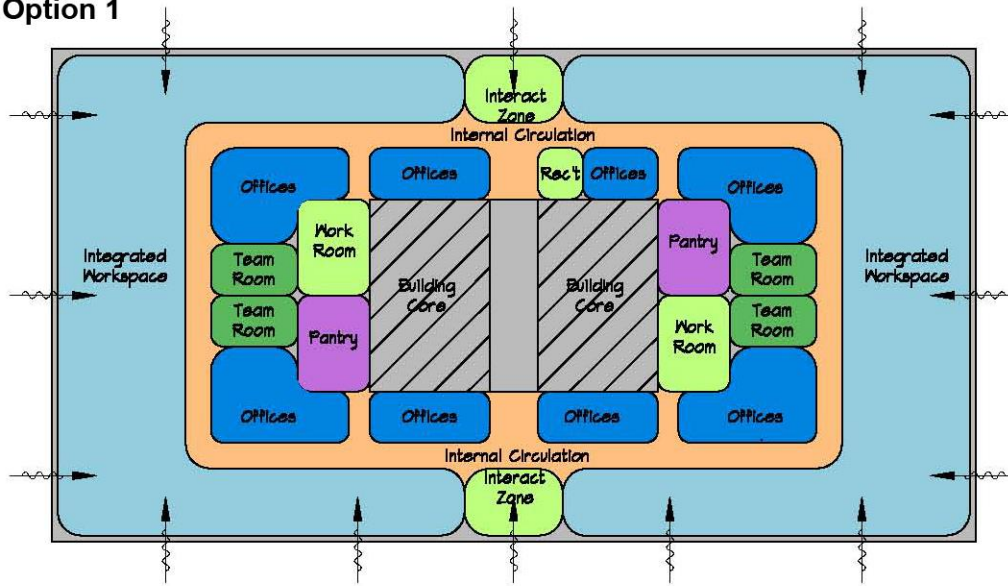

Option 2

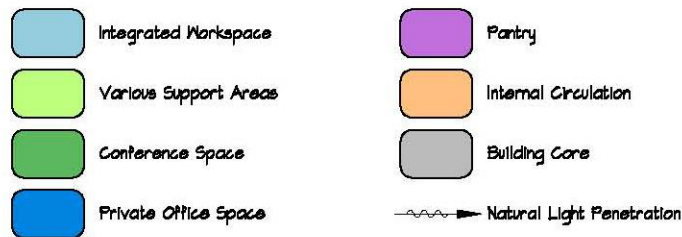
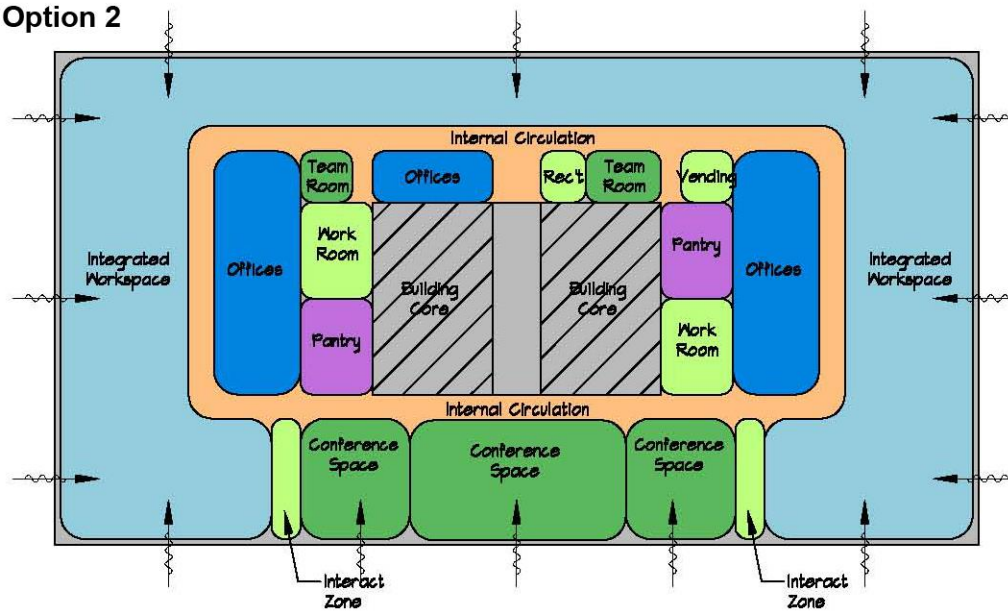

Option 3

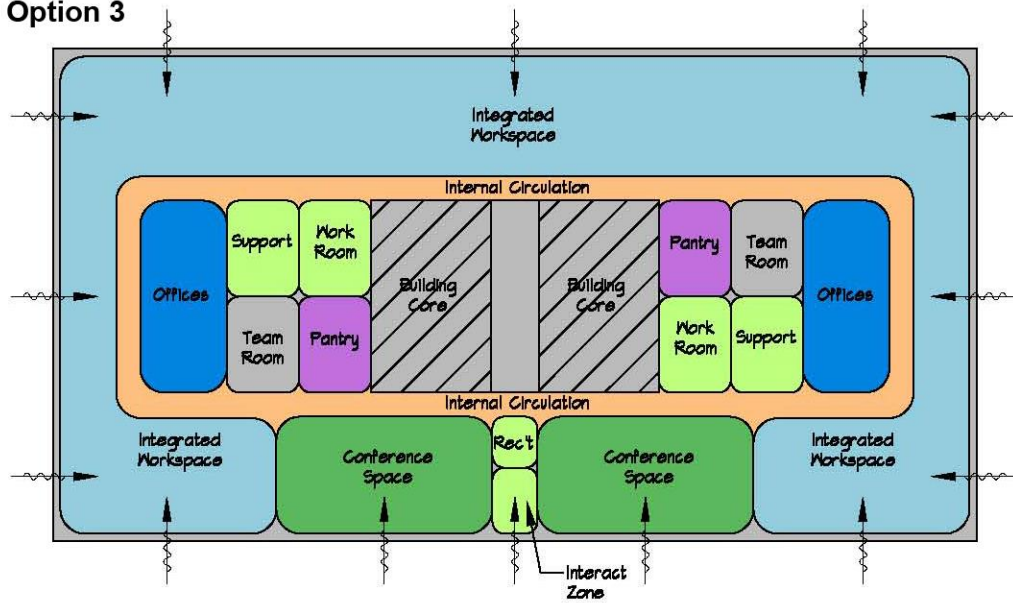

Option 4

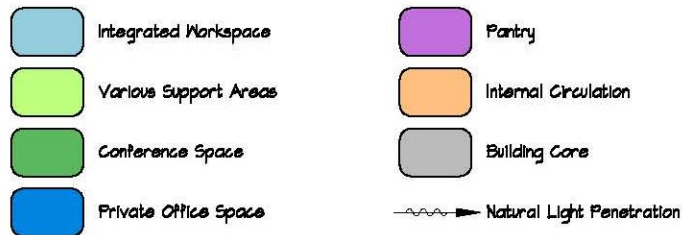
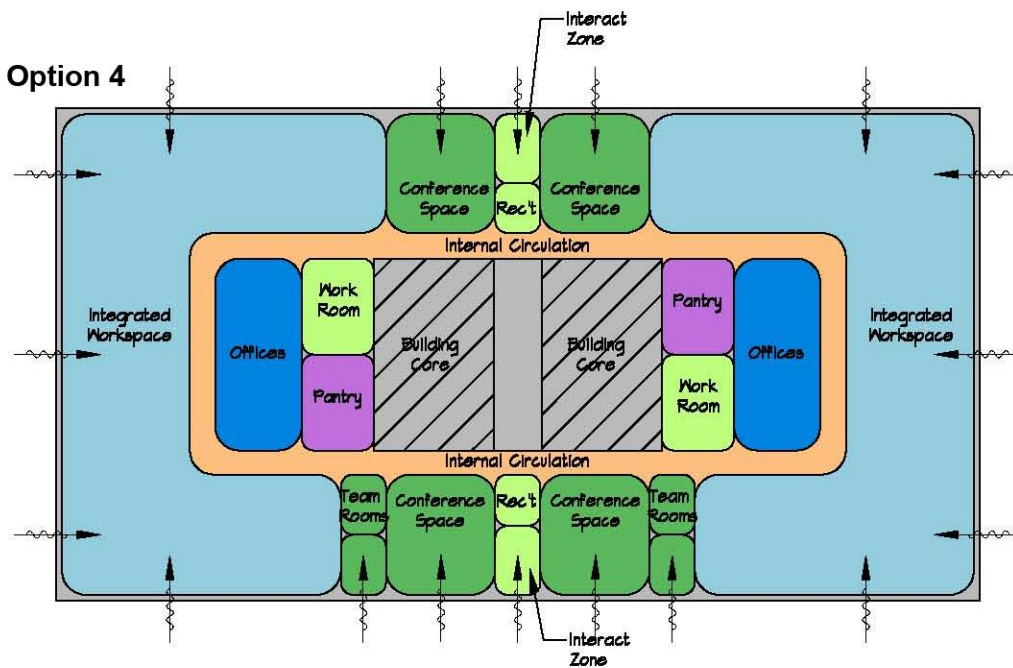

Option 5

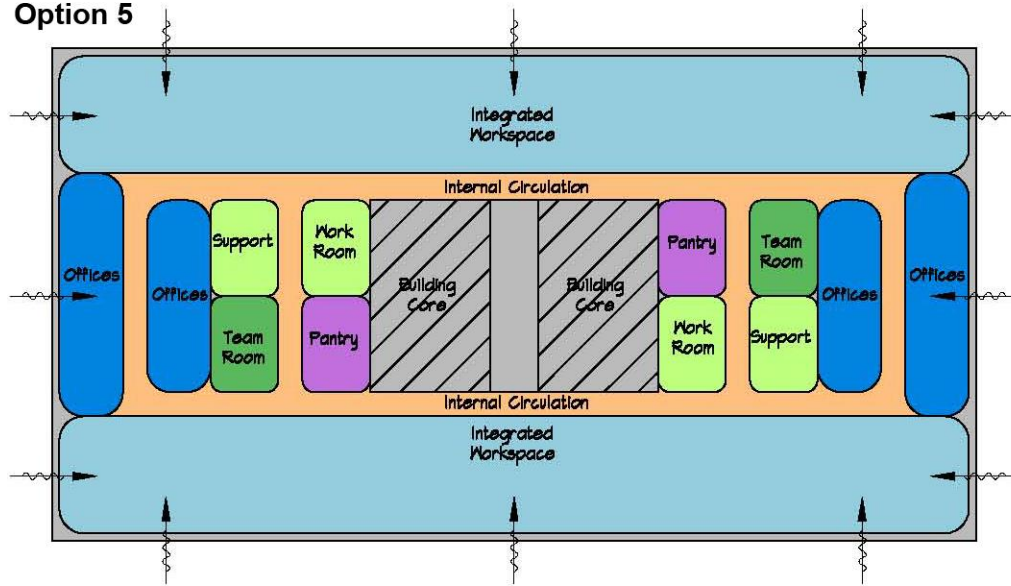

Option 6

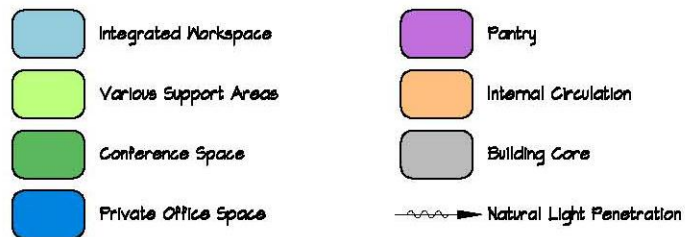
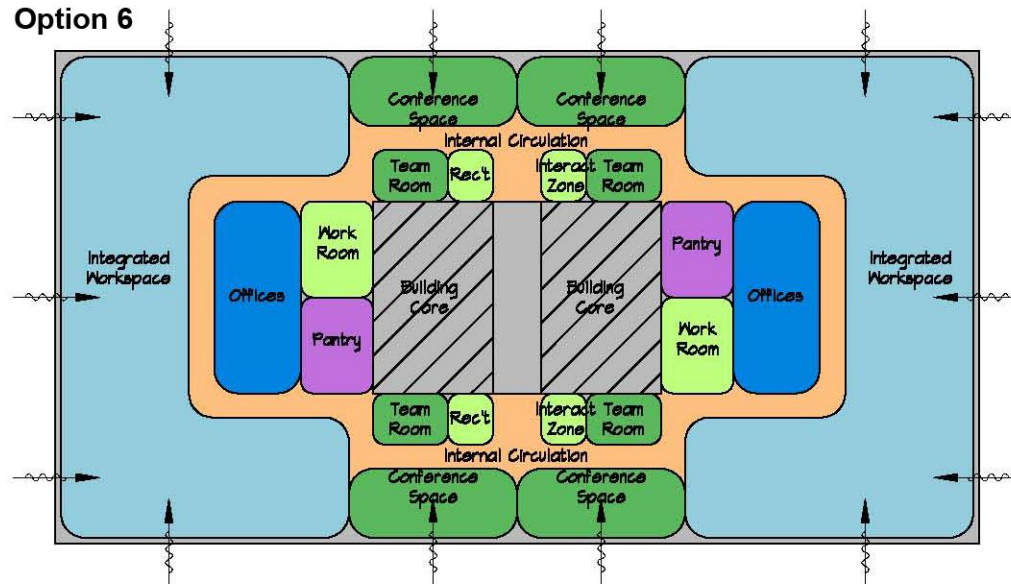

Option 7

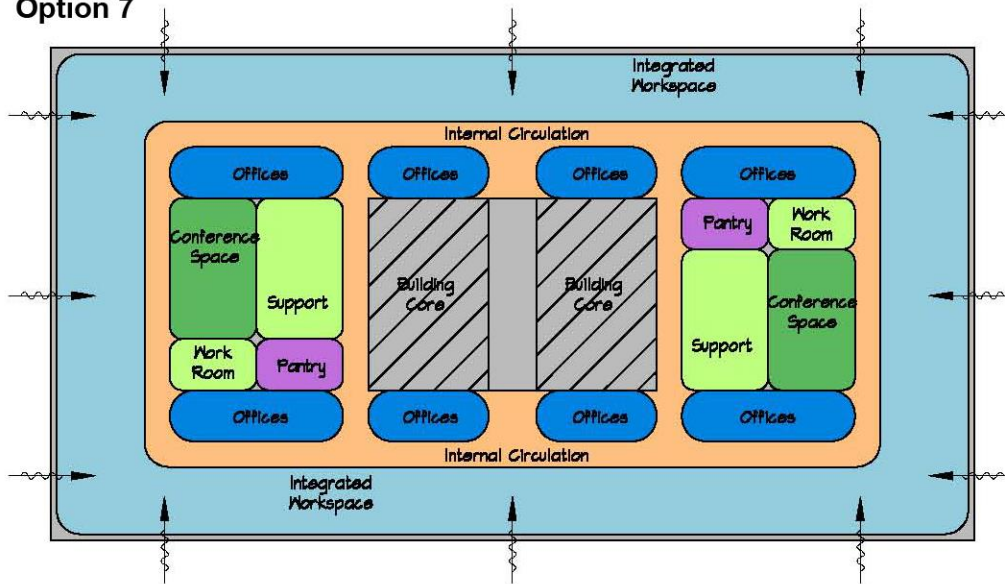

Option 8

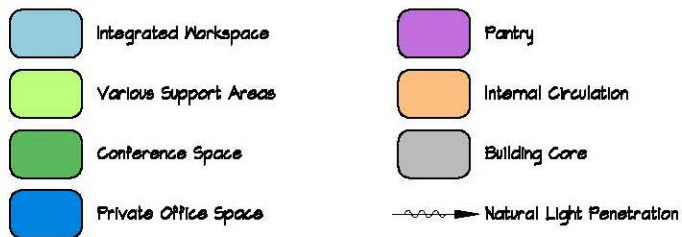
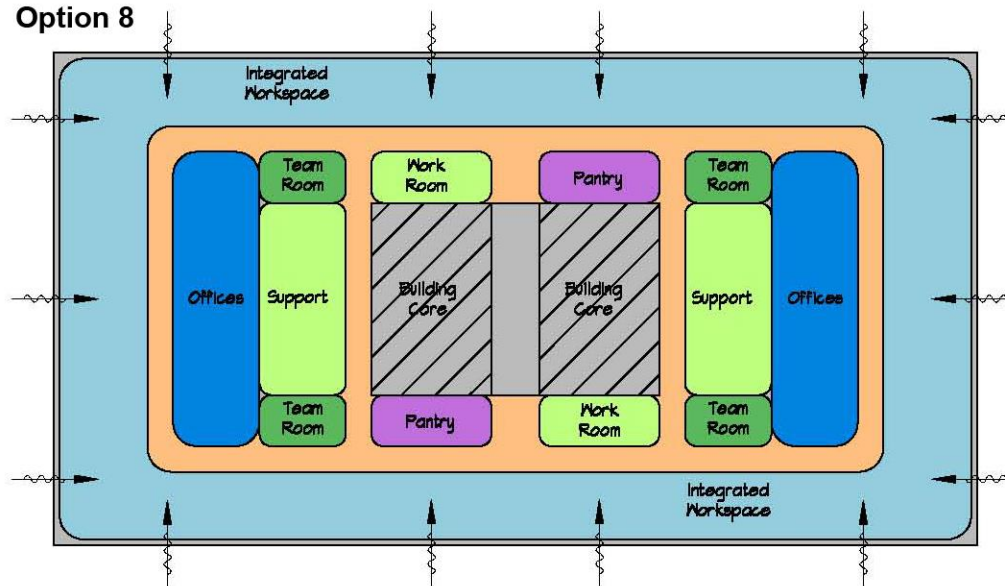

Option 9

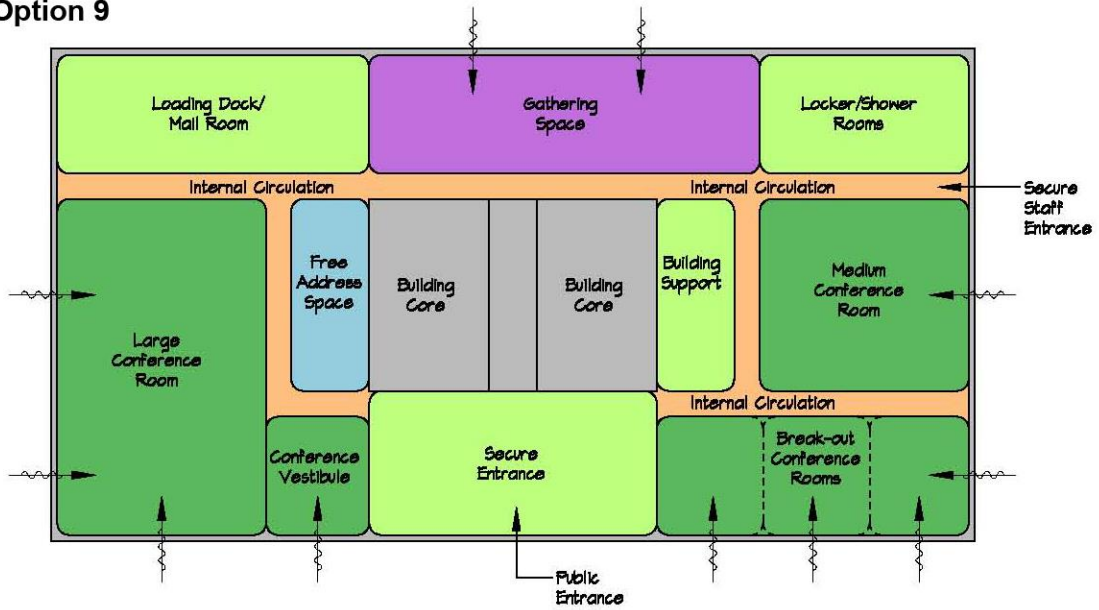

Option 10

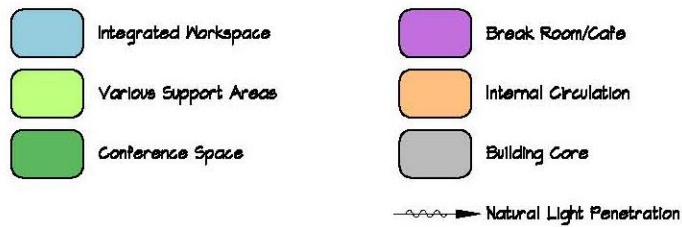
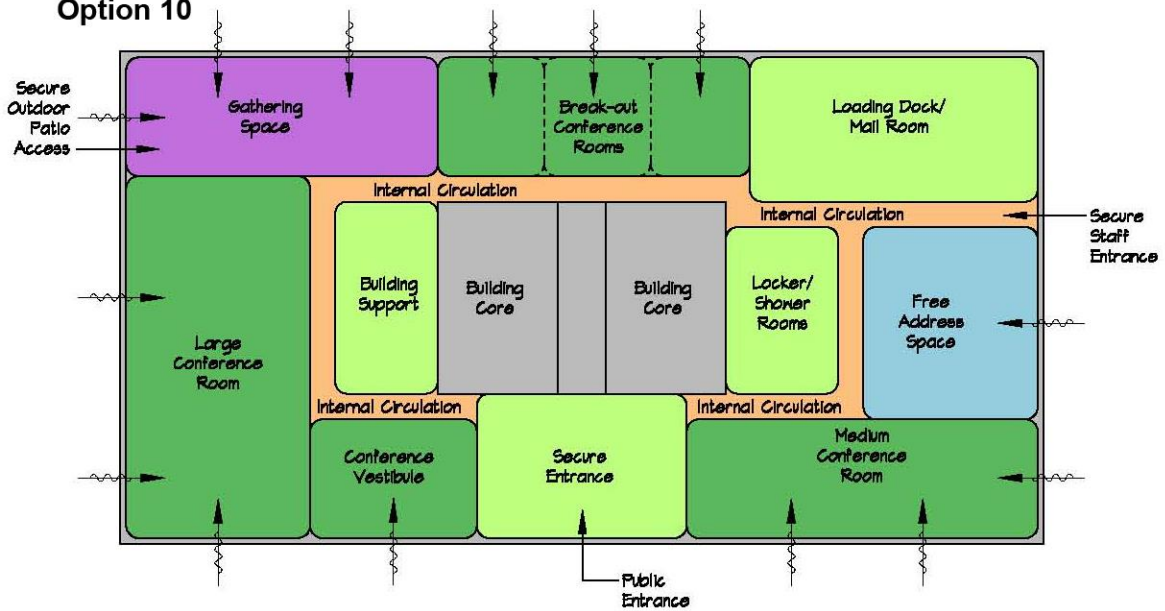

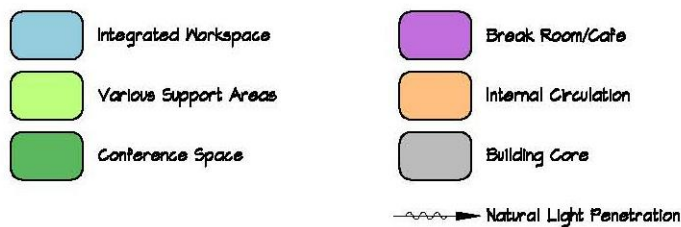
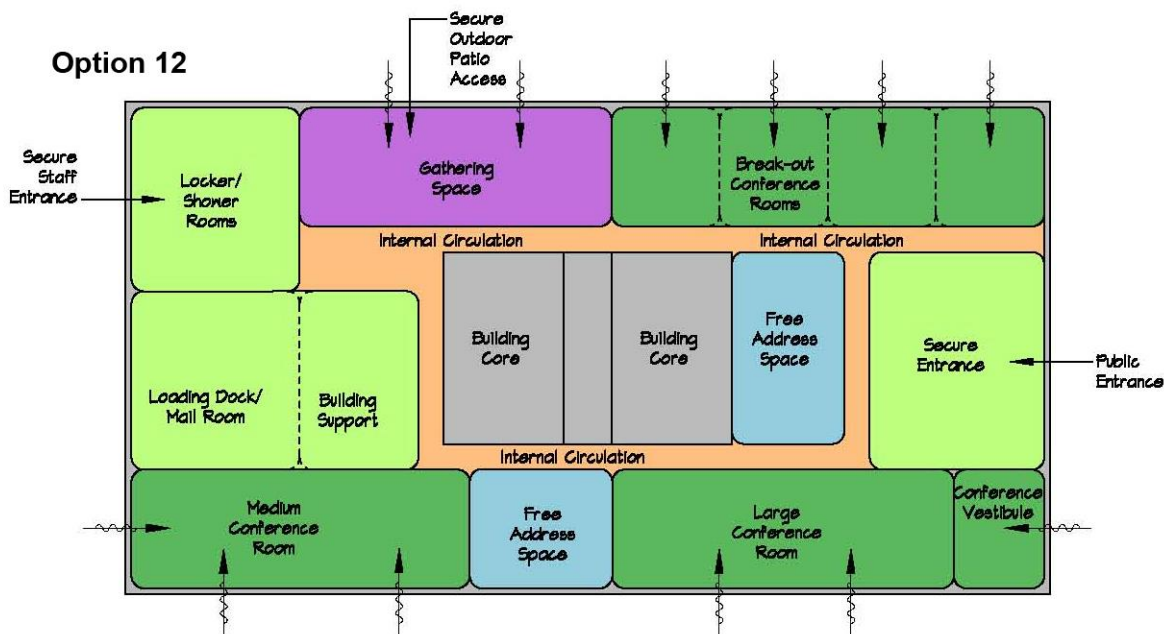
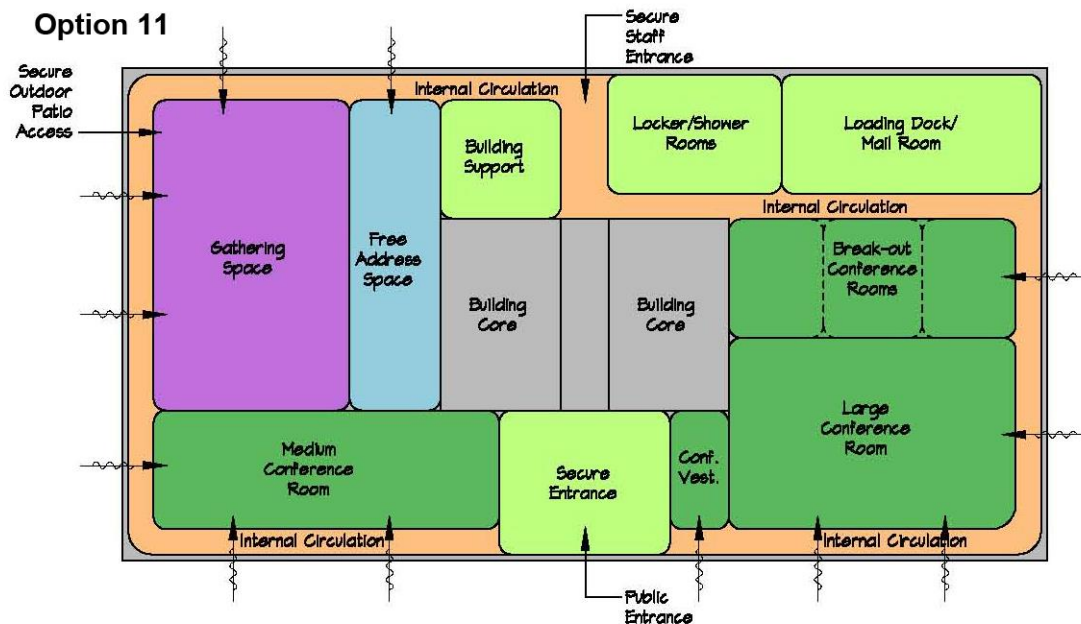

CHAPTER 7
FWS Space Request Procedures

This page is intentionally left blank

FWS Space Request Procedures**Types of Lease Space Acquisition**

- Lease Space Acquisition may cover the following types:

	Type	Description
1	New	Add a new space requirement to the space inventory.
2	Expansion	Add space to an existing space requirement.
3	Extension	Extend the term of the lease.
4	Succeeding	Maintain continued occupancy of space under an expiring lease agreement.
5	Superseding	When the requirements of an agency make it necessary to negotiate numerous or substantial changes to an existing lease, a superseding lease replaces the existing lease.

Executive Orders and Regulations

- FWS space management complies with the following list of authorities:
 - Code of Federal Regulations, 41 CFR 101-17 through 21, and 41 CFR 102-71 through 74, and 78 through 83, and 85.
 - Department Manual 425 DM 1 through 6.
 - The Rural Development Act, Farm Security and Rural Investment Act of 2002, Public Law 107-171.
 - Executive Order 12072, Federal Space Management – Central Business Area.
 - Executive Order 13006, Locating Federal Facilities on Historic Properties in Our Nation's Central Cities.
 - Executive Order 13327, Federal Real Property Asset Management.
 - Executive Order 13423, Strengthening Federal Environmental, Energy, and Transportation Management.
 - Executive Order 12941, Seismic Safety of Existing Federally Owned or Leased Buildings.
 - Executive Order 12699, Seismic Safety of Federal and Federally Assisted or Regulated New Building Construction.
 - The Randolph Sheppard Act, vending facilities for the blind in Federal buildings. All requirements necessary for the disabled-provided vending space is included in the lease package. The agency pays the cost of the space that the vending space occupies.
 - Davis Bacon Act of 1931 as amended.
 - Architectural Barriers Act Accessibility Standard (ABAAS).
 - FWS Manual – FW 370, Parts 1-3.

Start the Space Process

- Follow the Space Process Procedure as described in CFR 102-79.55 and 370 FW1, 2 & 3.

Step	Action
1	The Project Leader/field office must contact the Regional CGS Space Management Coordinator (SMC) to receive guidance and advice on the space management process, pertinent details, square footage needs, space utilization mandates, personnel, and costs.
2	The SMC estimates the rent using available market data, referencing current space bills if available, and/or by calling GSA.
3	The Project Leader/field office must refer 370 FW 2, “How to prepare a lease space request” in order to initiate the project.
4	If the space project overlaps fiscal years, the field office can label the certification with “subject to availability of funding for the FY...”
5	The certification of funds must be approved by the Program Office.
6	Once the SMC receives the approved leased space request and certification of funding, the SMC will coordinate with the Service Program and GSA to acquire the space.

Space Requirements

Development of the Program of Requirements

- The Regional CGS Space Management Coordinator, in conjunction with the field office, develops the Program of Requirements (POR) for the space leasing project. These are the specific space requirements needed to support the Program operations, which are incorporated into the GSA Request for Lease Proposal (RLP), see Chapter 9.
- When developing the Program of Requirements, consideration must be given to the number of personnel (employees, contractors, volunteers, etc.) in the organization (supported by an approved organization chart) needing space, and the type of operations that may require special space. Service Regions must comply with FWS utilization standards when determining and planning space needs. (Refer to Space Requirements Calculator for list of spaces to consider.)
- The geographical area where the space will be acquired is referred to as the “Delineated Area”. This area must be identified and comply with the Executive Orders regarding Central Business District and Rural Development Act. The delineated area must contain a large enough geographical area to provide adequate competition in the space acquisition process.
- The term of the lease contract must be determined, being careful not to create a capitalized lease.

Methods to Reduce Space Costs

- The following considerations help to reduce space costs:
 - Excess and/or obsolete items must not be maintained.
 - At no time can stored furniture units exceed the amount required to equip a maximum of 2% of the total authorized position ceiling housed in the office space.
 - A bi-annual office clean-up day is suggested to foster an efficient environment.
 - Encourage regular recycling of outdated materials or hard copies and duplicate copies available in electronic format.
 - Speed Filing Systems (available on GSA schedule) and/or other Filing Space Savers should be used in the filing areas or where records storage is mandatory.
 - No workstation should be allocated more furniture than required to function - all furniture is to be properly utilized (i.e., tables should not be used as bookcases and drafting tables as storage areas).
 - Share under used furniture.
 - Systems furniture is utilized whenever possible.
 - Systems furniture components should be standardized as much as possible to reduce costs.
 - Telework, part time or field positions spending 60% or more time in the field could share workstation space.
 - Consider providing joint work areas in open space for employee work areas, joint

- use drafting tables, team meeting areas, etc.
- Private offices should be kept at a minimum.
- Telework.

Collocation

- It is DOI policy that Bureaus collocate, to the maximum extent possible and where feasible, all offices to obtain an efficient and effective Service First (DOI initiative, see Glossary) outcome. In order to accomplish this goal, greater management oversight will be exercised at all levels of the organization to obtain this outcome.
- Since economics are part of the strategy, each collocated office that participates in the sharing of contract services, mailrooms, libraries, public rooms, conference rooms, break rooms, and other joint use space should considerably reduce the overall square footage at each individual location over separate locations.

Interagency or Cooperative Agreements

- Interagency or Cooperative Agreements are entered into and signed to outline and provide financial, mission and resource commitments between organizations to a firm term. The FWS Delegation of Leasing Authority issued by GSA does not provide authorization for agencies to conduct procurements of space on behalf of, or to collect rent from, other agencies. If the Interagency or Cooperative agreement is based in GSA owned or leased space, then an Occupancy Agreement between GSA and the Service for the portion of space the Service will occupy must be executed.
- As outlined in 370 FW 1, the Regional Director may approve non-monetary agreements between other bureaus, Federal agencies, State and local entities, and non-profit groups that provide temporary use of space for Service employees and operations (Refer to 370 FW 1. These agreements:
 - Must be authorized by statute and established for mission or cooperative purposes, and incidentally provide support space, and
 - Are executed as either an Inter-agency or Cooperative Agreement or Memorandum of Understanding (only a Contracting Officer can execute monetary agreements, after recommendation from the Regional/WO Space Coordinator)
- All known terms of the sharing of space and services are specifically outlined in the Interagency Agreement. There are several different formats for the Interagency Agreements—contact your servicing Space Management Coordinator or Leasing Contracting Officer for samples and specific Interagency Agreement formats.

Delegation of Leasing Authority

- In order to acquire General Purpose space (office and warehouse) for the FWS, the CGS Space Management Coordinator must request and receive approval of Provider of Choice delegated leasing authority from GSA's National Headquarters (located in DC). In addition, the FWS must first contact GSA's Regional Office to assure that no suitable federally owned or leased space is available to meet the requirement need and there are

no planned consolidations of Federal agencies in the community.

- There are four leasing authorities pertinent to the FWS space management program, three issued by GSA and one authorized by statutes: Provider of Choice Authority; Categorical Space Authority; Special Purpose Space Authority; and Independent Statutory Authority (originates in a statute enacted into law). **The FWS does not have Special Purpose Space (as defined in the FMR § 102-73.160) Delegation of Leasing Authority from GSA; or Independent Statutory Authority.**
- Examples of General Purpose space include: office, warehouse, laboratory and housing. General purpose delegation requires GSA approval. (Refer to 370 FW 3).
- Examples of categorical space include: docks, depots, hangers and mini-storage units. GSA delegation approval is not required for categorical space.
- On March 4, 2008 the Secretary of the Interior signed a memorandum pursuant to the October 26, 2007 delegation of space leasing authority from the Administrator of the General Services Administration authorizing delegated leasing authority for all functions related to leasing up to 19,999 rentable square feet of space. This authority may be re-delegated to employees of the FWS who have been trained and possess a warrant as a leasing contracting officer.
- There are significant expanded procedures that must be followed when using the delegation. The additional requirements that GSA has established have added an extra burden to the acquisition of space to meet program needs and should be carefully evaluated.
- The CGS Space Management Coordinator must request approval from GSA prior to conducting a specific leasing action.
- The following must be submitted to GSA prior to instituting any new, succeeding, extension, or superseding lease action under General Purpose delegation:
 - A detailed narrative, including cost estimates, explaining why granting the request is in the best interest in the FWS and how the FWS's use of the delegated authority is cost-effective for the Government;
 - The name of the warranted realty contracting officer conducting the procurement; such individual must fully meet the experience and training requirements of the contracting officer warrant program;
 - An acquisition plan for the procurement in accordance with the requirements specified by Subpart 507.1 – Acquisition Plans of the GSAM. D;
 - Justification for the delineated area in accordance with applicable laws and Executive Orders;
 - A floodplain check;
 - An organizational structure and staffing plan to support the delegation, identifying trained and experienced warranted contracting staff, post-occupancy lease administration staff, real estate legal support, and technical staff to ensure compliance with all applicable laws, regulations, and GSA directives governing lease acquisitions and administration of lease contracts;
 - A plan for meeting or exceeding GSA's performance measures (lease cost);

- The total amount of space required, any special requirements, and any associated parking requirements.
- If the awarded lease is for an average annual rental in excess of \$100,000.00, including option periods and excluding the cost of operational services, within 30 days after lease award, the FWS must submit to the GSA Director of Real Estate Acquisition Division, Public Buildings Service, the following documents or evidence of compliance:
 - A copy of the fully executed lease document and all attachments;
 - The Request for Lease Proposal (LRP) and any amendments issued during the procurement;
 - The pre-solicitation ad posted on FEDBIZOPS or in a local publication;
 - If a sole source contract, a Justification for Other Than Full and Open Competition;
 - The market survey data identifying properties considered in connection with the space need, including historic buildings considered;
 - Documentation of compliance with the National Environmental Policy Act of 1969, as amended, in accordance with 40 CFR 1508.9 and GSA guidance;
 - Documentation that vending facilities will be provided in accordance with the Randolph Sheppard Act;
 - The final scoring evaluation in accordance with OMB Circular A-11 (2002);
 - The Price Negotiation Memorandum;
 - Documentation that the building meets all applicable fire and life safety requirements;
 - The seismic Compliance Certification from Successful Offeror consistent with Executive Order 12699 for new buildings and Executive Order 12941 for existing buildings;
 - Copy of the Post-Award Synopsis posted in FEDBIZOPS;
 - The small business subcontracting plan;
 - Documentation that the Excluded Parties List was checked;
 - The pre-occupancy final inspection report verifying measurement of the demised space as shown on a CAD floor plan, correction of deficiencies, and punch-list items;
 - A Funds Availability Statement signed prior to lease award by a budget official;
 - Documentation that the negotiated rental rate is within the prevailing market rental rates for the class of building leased in the delegated action.
- To determine whether the delegation was in the Government's best interest, GSA shall evaluate whether a delegation was cost effective for the Government in the acquisition and delivery of space. GSA shall consider the negotiated rental rate, overhead costs, personnel costs, support contact costs, travel costs, accounting costs, and reporting costs. The FWS must provide, upon request by GSA, detailed acquisition costs.
- If the awarded lease is for an average annual rental of \$100,000.00 or less, including option periods and excluding the cost of operational services, the agency must submit to the GSA Director for the Real Estate Acquisition Division, Public Buildings Service, the following documents or evidence of compliance:
 - The fully executed lease document and all attachments;
 - If a sole source contract, a Justification for Other Than Full and Open Competition;
 - The market survey data identifying properties considered in connection with the space need, including historic buildings considered;

- The final scoring evaluation in accordance with OMB Circular A-11 (2002);
- The Price Negotiation Memorandum;
- Copy of the Post Award Synopsis posted in FEDBIZOPS;
- The small business subcontracting plan, if required;
- Documentation that the Excluded Parties List was checked;
- A funds availability statement signed prior to lease award by a budget official with the FWS.

This page is intentionally left blank

CHAPTER 8
Space Requirements Calculator

This page is intentionally left blank.

Space Requirements Calculator

Introducing the New Space Requirements Calculator

An important step in the space request procedure is determining how much space is required. A calculation tool has been developed based on the new space guidelines, as described in the following chapters. This spreadsheet will be posted on the FWS intranet for easy access. The calculator input can be completed by utilizing a combination of resources including an approved organization chart, existing space information (floor plans/survey) and end user interviews. There may have to be adjustments to quantities or sizes of space in order to achieve the desired 180 USF utilization rate. Multiple organization levels can be input separately and summarized on a program and then facility level.

Prospectus leases have a different Utilization Rate and circulation factor requirement. (Refer to the "Space Utilization" Chapter for more information.)

How to use the Space Requirements Calculator

1. Resources at hand during data input:

- a. Current space information (Optional)
 - i. Current lease or occupancy agreement
 - ii. Current floor plans with room use and size
 - iii. Current organization charts
 - iv. Current space survey (walk-through to evaluate space needs and adjacencies)
- b. Future space information
 - i. Occupant interviews (express needs and wants)
 - ii. Growth expectations
 - iii. Consolidation of functions and/or shared space opportunities
 - iv. Off-site storage opportunities
 - v. Budget limitations

2. Calculator Document set up:

- a. Questions to determine scope and design of document
 - i. How many groups will be included in the calculator?
 - ii. Which levels (Facility, Program, Division, and Branch) will be included in the calculator? See number 4 below for graphic.
 - iii. What year will the future projection be in the lease planning?
- b. General input tips
 - i. Input information only in light yellow cells. All other cells have formulas to automatically calculate.
 - ii. Hover over cells to activate pop-up information bubbles
 - iii. Click on cells to activate pull-down options

- iv. Items in light blue text are standards spaces described in the handbook
- c. Data input for all worksheet tabs in workbook:
 - i. Select all tabs, except “ExecutiveSummary”
 - ii. Select cell C1, enter “Project Name” and “Location Address”
 - iii. Enter “Current year (Optional)” for the date of the space study; and “Future year” for the first year of the new lease
 - iv. If it has been determined to not use the “Current” space situation information, select the column headings C-F, and hide “Current” columns
 - v. Deselect all worksheet tabs (Very Important – before proceeding)

3. Level 1 input:

- a. Select tab for “Level1Group1”, input.
 - i. Rename Tab with “Group Name”, i.e. Level1WSFR, do not use a space in the Tab name (Very Important – summary will not work with spaces in Tab name)
 - ii. Enter “Group Name” and “Date” at top of spreadsheet, Row 2
 - iii. Select cell C2, enter the name of the organization to occupy future space and the date of the input
 - iv. When revising the worksheet, select cell C3 to edit the version number to keep track of editions
- b. Current space input (if not using the “Current” space information, skip to c)
 - i. Total Rentable Area: Utilizing the lease or occupancy agreement input the current rentable square feet.
 - ii. Predicted Space Cost: Utilizing rent bill, enter current space cost for comparison purposes.
 - iii. Head Count Summary: This cell has a formula to automatically tally the offices and workstations to fill in the Total Occupants quantity.
 - iv. Section 1.1, Individual Workspaces, Offices: Utilizing current space plans and/or space survey enter the quantity of offices and their approximate sizes.
 - v. Section 1.2, Individual Workspaces, Workstations: Utilizing current space plans and/or space survey enter the quantity of workstations and their approximate sizes.
 - vi. Section 2.1, Office Support, Meeting Spaces: Utilizing current space plans and/or space survey enter the quantity of meeting spaces and their approximate sizes.
 - vii. Section 2.2, Office Support, Support Spaces: Utilizing current space plans and/or space survey enter the quantity of resource spaces and their approximate sizes.
 - viii. Section 3.1, Special Support Spaces: Utilizing current space plans and/or space survey enter the quantity of special support spaces and their approximate sizes.
 - ix. Section 3.2, Exempt Spaces: Utilizing current space plans and/or space survey enter the quantity of exempt spaces and their approximate sizes.

Future equivalents to these spaces would be required to have a waiver to be exempt from the Utilization Rate calculation.

- x. Section 4.1, Exterior Spaces, Warehouse Storage: Utilizing current lease information, enter quantity of existing warehouse storage. This type of space is not calculated in the Total Usable Area; and therefore, not included in the Utilization Rate.
- xi. Section 4.2, Exterior Spaces, Parking: Utilizing current site plans and/or site survey enter the quantity of parking spaces by designation and existing condition.
- xii. As the data is input, the summary at the top of the page will automatically complete giving the total of existing usable space, the distribution of space and the current utilization rate.

c. Future year input:

- i. Circulation Factor: Click cell and select from pull down menu the circulation factor. 35% is the default and 40% is an option. A different percentage can be typed in the cell, an error message will appear, click OK. A waiver will need to be acquired for a non-standard factor.
- ii. Fit Factor: This adjustment is provided to help alleviate the area lost due to estimated building floor plate inefficiencies. 4% is the default setting. 8% may be selected if the anticipated building is considered “odd” shaped. 0% may be selected if this adjustment is deemed unnecessary.
- iii. Predicted Annual Space Cost: Input estimated annual cost per square foot for new lease. A calculation using the Total Rentable Area will provide an estimated future space cost, excluding GSA, DHS and other fees.
- iv. Head Count Summary: This cell has a formula to automatically tally the offices and workstations to fill in the Total Occupants quantity.
- v. Maximum Space Allowance: Once the Total Occupants is determined, the Maximum Space Allowance is automatically calculated.
- vi. Section 1.1, Individual Workspace, Offices: Utilizing the organization chart and the space management handbook, enter the quantity of offices at the appropriate size (include vacant positions). If selecting an O1 office, choose a size from the pull down options. If a non-standard size is required, fill in the description at the bottom of the section (a waiver will be required).
- vii. Section 1.2, Individual Workspace, Workstations: Utilizing the organization chart and the space management handbook, enter the quantity of workstations at the appropriate size (include vacant positions). Select systems furniture or storage based furniture workstation size from the pull down options.
- viii. Section 2.1, Office Support, Meeting Spaces: After reviewing space survey and evaluating future needs enter the quantity of meeting spaces at the appropriate sizes.
- ix. Section 2.2, Office Support, Support Spaces: After reviewing space survey and evaluating future needs enter the quantity of resource spaces at the appropriate sizes.
- x. Section 3.1, Special Support Spaces: After reviewing space survey and evaluating future needs enter the quantity of special support spaces and the appropriate sizes.

- x. Section 3.2, Exempt Spaces: After reviewing space survey and evaluating future needs enter the quantity of exempt spaces and their approximate sizes. These spaces would be required to have a waiver to be exempt from the Utilization Rate calculation.
- xii. Section 4.1, Exterior Spaces, Warehouse Storage: After reviewing space survey and evaluating future needs enter the quantity of and the appropriate sizes of warehouse storage. This type of space is not calculated in the Total Usable Area; and therefore, not included in the Utilization Rate.
- xiii. Section 4.2, Exterior Spaces, Parking: After reviewing current quantities and evaluating future needs enter the quantity of parking spaces by designation.
- xiv. As the data is input, the summary at the top of the page will automatically complete giving the total of usable space, the distribution of space and the utilization rate. Please note that the UR will **NOT** be accurate until all of the input is complete due to the distribution of the shared space. See below.

- d. Select tab for “Level1SharedSpace”, level 1 input.
 - i. Enter “Date” after “Shared Space” in cell C2.
 - ii. Shared Space should be any space that is corporately controlled and not for the sole purpose of one group. The total square feet are prorated for each group in its Utilization Rate calculation.
 - iii. Follow directions for Current space input and Future (year) input above to complete worksheet.
- e. Start over from 3 for each Group.

4. Select tab for “Level1Summary(Level 2)”:

- a. Most of this tab is automated.
- b. All of the Level 1 tabs are summarized on this worksheet, creating Level 2.
- c. Enter “Level 2 Group Name” and “Date”

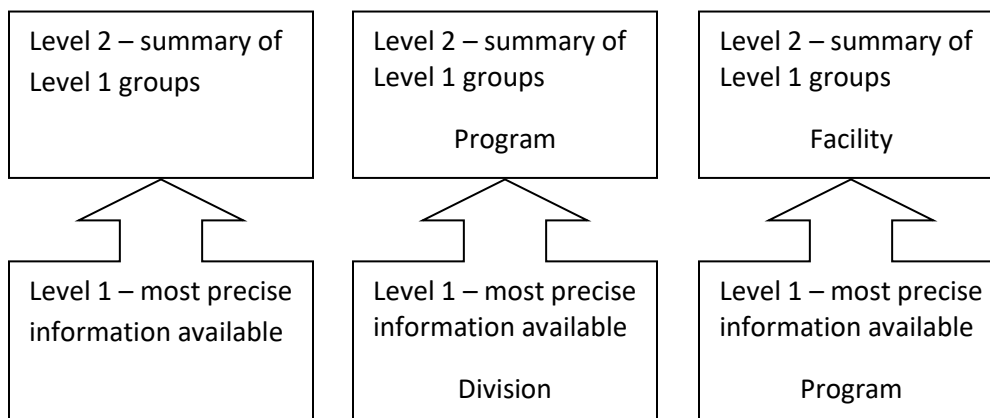

5. Select tab for “Executive Summary”:

- a. Except for the project title, this entire spreadsheet is automated.
- b. Customize the summary by hiding any unused rows and duplicating signature blocks as necessary.

This page is intentionally left blank

CHAPTER 9
GSA Space Leasing Process

This page is intentionally left blank

GSA SPACE LEASING PROCESS

What Can GSA Do for the Space Management Coordinator and FWS?

- GSA can help the Space Management Coordinator and FWS in the following areas:
 - Provide first class office space.
 - Assist with legal issues on the lease.
 - Provide 120-day termination rights at any time during the lease.
 - Provide building management services.
 - Space planning and design services.
 - Order furniture.
 - Provide alteration requirements.

- Many “trouble spots” that Space Coordinators encounter with GSA include:
 - Delayed space acquisitions.
 - Delayed building management corrections.
 - Billing problems and delayed corrections to the bill.
 - Frequent turnover of GSA Realty Specialists causing customer service issues.
 - Rent appeals are made to GSA, rather than an “independent third party”.
 - Consistency between Realty Specialist and GSA Regions.
 - GSA’s “re-measurement” of currently occupied space.

Issues Commonly Overlooked During Lease Planning

- The following areas should not be overlooked in lease planning:
 - Collocation opportunities.
 - Responsibility of FWS Programs for funding of move, furniture (new or relocating existing) and above standard Tenant Improvement costs and procurement.
 - Data and Telecommunication equipment and wiring – purchasing, moving and reinstallation.
 - Reimbursable cost items as identified in the Special Requirements.
 - Any change orders or requests made after award of the lease.
 - Security requirements.
 - Surplus furniture disposal.
 - Developing a plan for “house cleaning” of present space.
 - Budget and purchase of Filing Systems and/or other Filing Space Savers.
 - Workload and staff to coordinate all issues associated with moving to new space.

Requesting Space from GSA

- To initiate and start the space request process, only the CGS Regional Space Coordinator should contact GSA.

- GSA will accept any of the following paperwork to initiate a space action. The paperwork must be signed/initialed by the Space Management Coordinator (with the authority to bind the FWS financially).

- Standard letter or memo
- Request for Space (SF-81)
- Space Requirements/Questionnaire

Advertisement

- Prior to GSA placing the advertisement in the local paper, the CGS Space Management Coordinator must review the advertisement. The advertisement will describe the requested delineated area and the total amount of needed space. Various other types of advertisements are also used, which include Fed Biz Opps, realtor contacts, and phone surveys. After responses to the advertisement are received, a market survey is scheduled by GSA, the Space Management Coordinator, and the local field office to view the potential sites or buildings.

Market Survey

- A Market Survey is a field survey of the area under consideration for a lease requirement for the purpose of obtaining information on market conditions and the availability of suitable space.
- The FWS representatives who participate in the Market Survey are required to sign Procurement Integrity Forms at the onset of the market survey. The Procurement Integrity Forms are used to ensure confidentiality of the offerors and sites. The Market Survey will inspect all prospective locations and/or existing spaces to determine whether the proposed offer can meet the minimum space requirements and award factors. The market survey is also used to identify potential or undesirable features. If a property is to be excluded from consideration, adequate justification must be documented. After agreement is reached on the acceptability of locations and/or existing space, a Request for Lease Proposal is issued to all prospective offerors.

Request for Lease Proposal (formerly Solicitation for Offers)

- A Request for Lease Proposal (RLP) is prepared by GSA, which includes GSA minimum specifications, applicable Federal laws and regulations, the level of required services, and the FWS special requirements information.
- The following are categories of standard space requirements and specifications which are a part of the Request for Lease Proposal (RLP). (Refer to the Appendix for the sample RLP).
 - Summary
 - Award Factors
 - Miscellaneous
 - General Architecture
 - Architectural Finishes
 - Mechanical, Electrical and Plumbing
 - Services, Utilities and Maintenance

- Safety and Environmental Management
- Lease Security Standards.

Note: The CGS Space Management Coordinator will review each solicitation package for your offices' space requirements to ensure that these have been included.

- The RLP is mailed to all prospective offerors with approved sites and/or approved existing space. GSA establishes a date for submittal of initial offers. GSA will not consider any proposal received after due date for receipt of offers unless exceptions for late offers exists. Any changes to the RLP must be given to all offerors through an amendment to the solicitation.
- To be a valid offer, the offer must be signed by the offeror or an authorized agent who must submit proof of their authority. Information regarding the number of offerors, the identity of the offerors, and the specific offers must remain confidential and secured.
- GSA conducts negotiations with each offeror. Negotiations provide an opportunity for the offerors to change their offer and ensure it is complete. GSA requests best and final offers from the offerors at the conclusion of negotiations. Return of the best and final offers signifies the close of negotiations. All offers must remain open until the award is made. GSA bases its evaluation and award on the best and final offers that are received.
- At the conclusion of negotiations, a synopsis of the principal elements of the price negotiation should be prepared and maintained in the lease file. At a minimum, the Price Negotiation Memorandum (PNM) must contain the following information: Purpose of the negotiation, description of the acquisition, including the identifying solicitation number, the name, position, and organization of each person representing the contractor and the government in negotiations.

Occupancy Agreements

- Occupancy Agreements (OA) are the formal written agreement between GSA and the agency or bureau defining the duration, financial terms and conditions for the occupancy of GSA controlled space. Both parties sign the agreement. The OA should be a living document that changes as conditions of the requirement, market rent rates change, and final occupancy numbers are completed. A tenant agency should receive a draft OA at the beginning of the project, revised OAs as changes occur, and a final OA upon occupancy of the space.

Award of the Lease

- GSA will prepare an abstract reflecting the details of each offer received. The Space Management Coordinator must contact their GSA representative for this information in order to provide comments. GSA will not give this secured information to anyone else. Using the same format for each offer, the abstract should provide the information to determine if the offeror is able to meet the minimum requirements of the solicitation.

- The offers will be evaluated regarding price, technical requirements, and award factors in strict accordance with the terms and conditions of the solicitation. Award determination is based on a final abstract of offers. The award, based on best value, is made to the offeror whose offer will be most advantageous to the government, price, and other award factors considered. Other award factors can include:
 - Quality of the site,
 - Experience and past performance of the developer and contractor,
 - Key personnel used,
 - Quality of design,
 - Construction management plan and
 - Proximity to mass transit.

- The following items will be incorporated into the lease:
 - SF-2 or GSA Form 3626, "U.S. Government Lease for Real Property".
 - Date of Lease.
 - Lease Number.
 - Description of premises which includes the identification of the property, the amount of square footage, name of building, street address, room and floor numbers, city, and state zip code.
 - Parties, i.e. Lessor, and Government.
 - Contract annual rent, monthly rent, and payee.
 - Lease term.
 - Termination rights.
 - All other rights – i.e. Base cost of services rate, vacant premise rate, percent of occupancy.
 - Required clauses from the FAR and GSAR.
 - Solicitation and all attachments and/or exhibits.
 - 3516, "Solicitation Provisions".
 - 3517, "General Clauses".

3518, "Representations and Certifications".

- The CGS Space Management Coordinator must ensure their GSA Representative provides a copy of the lease and its subsequent Supplemental Lease Agreements (modifications to the Lease) to them. All steps of the space acquisition process must be documented thoroughly. (See Appendix for GSA Lease Checklist.)

Space Planning (Post-Award)

- The Space Management Coordinator, in conjunction with the field office, (if the project is collocated then representatives of all agencies) will participate in the space layout planning process. The representative(s) that will participate in the space layout need to be familiar with the specific office space needs as they relate to adjacencies and/or joint use of various types of spaces. In order to provide an efficient layout design, space-planning services can be provided by the Lessor and/or GSA. The following space programming issues should be considered prior to the initial meeting with the space planner:
 - Space Requirements Calculator: Has a worksheet been developed to quantify various working groups in square footage allocations? Has the circulation figure been quantified for the overall space?
 - Adjacencies: What blocks and/or groups of people and/or space need to be located together? What other groups does a particular block interact with daily?
 - Housing: Which small groups could go anywhere - can be used as “space fillers” if necessary? Which groups could be split?
 - Filing/Storage: What type and what size of storage areas, file areas or any other support areas are needed with a particular group of people?
 - Special Space: Are there any unusual or unique space need(s)?
 - Fixture Selection: What type of furniture will be installed?
 - Security: How will the building will be secured? Are there any special security needs?
 - Union: If there is a union involved, with management approval, has the union been included and informed of the various space decisions?

Construction, Inspection, and Acceptance

- GSA must stay in contact with the Lessor, the Space Management Coordinator, and the local field office personnel during the construction to ensure that the space is being constructed as required. Local field office personnel must not be on the construction site without pre-approval from GSA and/or with a GSA representative present.
- GSA will coordinate a final inspection to include representatives of the office actually using the space. After the space is completed, it is inspected to ensure that all the terms and conditions of the lease and the final space layout drawings are provided. The Lessor must provide a certification of occupancy for the building/space. A punch list is compiled for all remaining items to be completed and a determination is made regarding substantial completion of the space.
- The Lease Agreement and Occupancy Agreement (OA) are adjusted, if necessary, to correct the occupancy date, verified square footage, and rent. A final space measurement must be completed to ensure the accuracy of the lease and the annual rent paid by the FWS.

Move

- Be sure to inform the local field office that all expenses associated with the move will be paid by that field office; this includes: moving, furniture, data and phone lines. The cost to move systems furniture is most expensive, due to the disassembly in old location and

reassembly in the new location. The FWS is responsible for hiring a contractor to pull the cable for the phone lines and data lines. The Lessor is responsible for providing the point of demarcation, conduit, and the outlet box only. The FWS contractor pulls the wiring for the phones and data. The Space Management Coordinator and the local representative will coordinate the move to the new location. Refer to the GSA Cost Per Person Model User Manual and the Move Checklist, both located in the Appendix.

Post Occupancy Services Provided by GSA

- A set of activities which can include space layout, interior design, construction, construction management, price analysis and negotiation, inspection, physical moves of furniture and equipment, relocation management, move coordination, personal property purchases, and integration of all of the above.

Daycare Facilities

- The daycare facility rent program is an initiative from GSA. Any agency within a GSA-specified radius of a federal childcare facility will be charged a prorated share of the rent costs for the daycare facility, even if your agency does not have children under the daycare facility's care. There is no way to appeal the charges of this initiative. GSA will assess the rent to all agencies in the immediate area.

Note: Government employees are allowed access to use the facility.

GSA Regional Account Managers for the DOI/FWS

GSA Regional Account Managers for the 12 Regions include:

Region	Covers	GSA Regional Account Managers
1	New England Region ME, VT, NH, MA, CT, RI	Scott Raeside 617-565-8174
2	Northeast & Caribbean Region NY, NJ, Caribbean	Adam Schaffer 212-264-1407
3	Mid-Atlantic Region PA, MD, DE, WV, VA	Justin Owens 215-446-5712
4	Southeast Region KY, TN, NC, SC, MS, AL, GA, FL	Hillary Montgomery 404-331-0077
5	Great Lakes Region MN, WI, MI, IL, IN, OH	Lilly Ferrer 312-353-9631
6	Heartland Region NE, IA, KS, MO	Wendy Dent 816-823-1176 Karla Wallace 816-926-5207
7	Greater Southwest Region NM, OK, AR, TX, LA	Zack Giles 817-978-7159
8	Rocky Mountain Region MT, ND, SD, WY, CO, UT	Dawn Warner 303-236-8000 x2268
9	Pacific Rim Region CA, HI, NV, AZ	Leslie Jackson 415-522-3061
10	Northwest/Arctic Region AK, WA, OR, ID	Kate Betz 253-931-7502
NCR	National Capital Region Washington, D.C.	LaShawn Cambrel-Brock 202-260-4993
	National Account Director Only to be contacted by WO-CGS	Jennifer Kendall 202-208-0139

This page is intentionally left blank

CHAPTER 10
Lease Administration, Alterations and Reporting

This page is intentionally left blank

Lease Administration and Termination

General Lease Administration

- GSA has building management authority at all GSA controlled facilities (leased and Federal). Therefore, when the Lessor fails to provide services, utilities, or maintenance in accordance with the terms of the lease, the following process will take place:

Step	Action
1	The Space Management Coordinator contacts GSA.
2	GSA gives the Lessor a written notice on the failure and the need to comply. Note: Under emergency conditions, GSA may inform the Lessor verbally with a confirmation in writing.
3	If the Lessor fails to respond, GSA sends a second written notice, which includes a reference to the Failure in Performance Clause within the lease that states the Government's option to correct the deficiency and deduct all costs from the rent.

- GSA handles all lease administration issues, including, but not limited to the following:
 - Enforce lease performance requirements.
 - Negotiate and document changes.
 - Adjust rental rate for Consumer Price Index (CPI) and tax escalations.
 - Settle claims or protests.
 - Day-to-day maintenance and operating matters.
 - Space alterations.
 - Novation agreements (change of building ownership).
 - Statement of Fact or Statement of Lease.
 - Vacant Premises Adjustments.
 - Lease extension.
 - Termination of the lease.

Space Alterations in GSA Controlled Space

- Alterations to GSA-controlled space by FWS personnel are prohibited. FWS Programs are not authorized to deal directly or indirectly with the Lessor for alterations and repairs unless authorized in writing to do so by GSA and the Space Management Coordinator. Alterations, improvements, and/or repairs to space occupied by the FWS will be made only as necessary to:
 - Provide for efficient and economical performance of FWS activities.
 - Improve utilization.
 - Maintain and improve a safe, healthful, and well-designed working environment for employees.

- All alterations to GSA space are provided on a lump-sum reimbursable basis only upon request of the Space Management Coordinator and subject to GSA approval. Such reimbursable work will be funded by the requesting office and charged to the benefiting sub activity.

Note: Space Management Coordinators can refer to **370 FW 3: Managing and Relinquishing Lease Space**, for more information on requesting alterations and Capitalization requirements for lease space alterations.

Space Alteration Guidelines

- When a request for a leased space alteration is received from the field office, the Space Management Coordinator will meet with the requestor to get an understanding of the proposed alteration and to develop the scope of work to send to GSA. The scope of work is used to inform GSA and the Lessor exactly what work is to be performed.
- Before the scope of work is completed, the Space Management Coordinator will determine if there are any alternatives that can accommodate the request. In addition, the following must be considered:
 - Does the proposed alteration project impact any other area of the space?
 - Does the alteration project have any impact on accessibility or life-safety requirements?
 - Will the alteration require modifications to communications, electrical, plumbing, HVAC, fire protection, systems, etc.?
 - Will any parts of the alteration need to be performed after normal business hours?
 - Review the lease to ensure that the alteration request will meet the already established standards, i.e., greening, indoor air quality, minimum lighting, paint, or carpet requirements, HVAC ranges, etc.
 - Take into consideration the economics of the project and determine if there is a more cost-effective approach that will accomplish the goal.
 - Will the alteration impact existing or require future maintenance that has potential to increase maintenance or janitorial cost (i.e. if an exhaust fan is being added, will a filter need to be cleaned or replaced periodically? If walls are being added, will the walls be added to the cyclical painting requirement? If a room is being carpeted will the Lessor be required to add the carpet that is newly installed to his/her/their cleaning, and/or replace it when it is worn out?).
 - Future maintenance requirements can impact the operating costs.
 - If the alteration project adds space to the facility, be sure to recalculate the utilization rate to assure that the new utilization rate does not exceed 180 BOMA usable square feet per person.
 - In the scope of work, provide as many details as are appropriate to obtain the requested finished alteration.
 - Establish a reasonable timeframe for completion of the project.
 - Prepare an independent Government estimate for each alteration project.
 - GSA will contact the Lessor, negotiate a cost for the alteration, request a waiver of restoration, and arrange for payment of the completed alteration.
 - GSA will not authorize payment for alterations until the work is inspected by appropriate local, city or county authorities; a qualified Government employee

- and/or independent Government contractor.
- If a Waiver of Restoration clause is not contained in the Lease contract, or the Lessor refuses to execute the waiver, prior to commencement of the alteration project, the local management must decide if they are willing to assume maintenance for the alteration and restore the space to its original condition when the lease expires.

Note: Space alterations over \$100,000.00 are considered a capital improvement. All capital improvements must be capitalized by CGS. **Refer to 370 FW 3:** Managing and Relinquishing Lease Space for additional information and requirements.

Vacant Premises Adjustment

- If the government vacates all or a portion of the leased premises before the expiration of the firm term then the vacant premises rate is used to determine the amount of the rental rate deduction. The vacant premises rate is intended to reflect the amount of the services that would *not be needed* if the space was vacant, i.e. janitorial services. If a portion of the space is vacated it should be a "leasable block". The paragraph can be implemented if the original lease contract established a vacant premise rate with the proper written notice. The amount of the vacant premises rate is established in the SF-2 portion of the lease.

Lease Termination - Moving Out

- The "last inspection" is done by touring all parts of the vacated leased space. The purpose of this report is to document the condition of the space at the time of moving out and to help establish responsibility for any damages. This report also helps to protect the government against false claims for damages.
 - The Lessor or his/her/their authorized representative should participate in the inspection.
 - GSA and the FWS representative will look for damage, which was caused by the government or its agent (moving company) such as gouges in walls, holes in doors, and/or rips in carpet.
 - Do not be concerned with "normal wear and tear" items, such as furniture indentations in the carpet, worn carpet areas in high traffic areas such as corridors, or marks on the walls which require only painting.
 - If possible, a narrated video is the best documentation. The video should be taken with the Lessor. Be sure to talk about the location of the areas that are being recorded. If it is not possible to take a video, be sure to document the extent and location of all damages with photos.
 - If a dispute arises regarding damage or "normal wear and tear", take photos and write a complete description of why it is "normal wear and tear" versus repairable damage. This documentation will be used to negotiate a settlement or defeat a claim.
 - The parties participating in the inspection should sign the report.
 - Each party should retain a copy.

- All government property must be removed from the space. Until the space is completely vacated the Lessor is entitled to rent.
- All keys, access key cards, etc. must be returned to the Lessor and a receipt obtained for the file.

Leased Space Reporting Requirements

- Federal Real Property Profile (FRPP) Reporting Requirements for General Purpose, Categorical, and Special Purpose Leasing Delegations:
- In accordance with Executive Order 13327, Federal agencies are required to submit data for assets in their real property inventory to the FRPP. Agencies are required to provide data on all leased assets acquired under a delegation from GSA. Regional CGS Space Management Coordinators are required to enter and report in the Financial and Business Management System, each new lease space asset acquired under our Delegation of Leasing Authority; and space acquired under a Memorandum of Understanding, Interagency Agreement, or an Intra-Agency Agreement.
- GSA reserves the right to request additional information on the FWS' delegated lease activities based on the data submitted to the FRPP. Failure of the FWS to timely or fully provide this additional information may result in GSA's revocation of the delegation to the FWS.

CHAPTER 11
Occupancy Agreement

This page is intentionally left blank

Occupancy Agreement

Occupancy Agreement for GSA Controlled Space

- GSA prepares and assigns an Occupancy Agreement (OA) for all GSA controlled space assignments. The OA outlines terms and conditions between GSA and the Agency and is used for funding obligations. A draft OA must be signed by both parties and provided at the start of the space project to allow GSA to proceed with the leasing action and the FWS office to budget for the potential space costs. The OA can change throughout the lease project. A final OA will be provided at the completion of the project after the tenant moves into the space. The final OA should match what the new rent bill will show. The Occupancy Agreement sets forth the specific costs and terms of the space assignment. A CGS Chief may authorize an OA; or a Contracting Officer with a Leasing Warrant with concurrence from the Chief, CGS.
- In newly occupied spaces, there is an amount designated as “Amortized Tenant Improvement - Customization Allowance Used”. This amount makes up a portion of the annual assignment charge.
 - In GSA leased space, if the FWS releases the space to GSA prior to the expiration of the firm term, under the terms of the Occupancy Agreement, the amount of the unamortized tenant improvements must be fully reimbursed as a lump sum payment to GSA.
 - In GSA controlled Federal space, if the FWS releases the space to GSA prior to the expiration of the occupancy agreement, the amount of the unamortized tenant improvements must be fully reimbursed as a lump sum payment to GSA.
- The OA charges the agency for the Rentable Square Feet and provides a formula for conversion (R/U Factor) to figure the BOMA Usable Square Feet. In addition, the OA has Shell Rental Rates (General Use and Warehouse), Amortized Tenant Improvements, Operating Costs, Real Estate Tax, PBS Fee, Parking, Joint Use Costs, Antenna Bill and Reimbursable Services Bill.
- GSA Rent Bills for Space and Services are submitted to the FWS Budget Management and Operations Office (Washington Office) on a monthly basis.

Occupancy Agreement Termination Rights

- Each Occupancy Agreement (OA) must be checked for specific termination rights, i.e. 120-day written notification. If GSA determines that the space will not have termination rights, the FWS is financially responsible for the space for the entire firm term of the lease agreement, as stated in the OA. This space cannot be released to GSA with 120-day notification. (In some cases, a 2% discount is given to agencies for leased assignments in which GSA views the space to be non-cancelable.)
- In order to terminate a portion of the space, the FWS must identify a leasable block of space. Under the provisions of the Federal Management Regulations, the FWS can give GSA 120-day notice that the FWS intends to vacate the space. In addition, the FWS will

be obligated to reimburse GSA for any space alterations that are necessary to block off the space in order to make it a leasable block of space. At the completion of the 120-day, GSA will no longer bill the FWS for the relinquished space.

- The FWS may also terminate the space in its entirety by giving GSA 120-day notice to terminate. If the FWS terminates a portion of the space or in its entirety during the firm term of the lease, the FWS will be obligated to pay for the unamortized portion of the tenant improvements. (Refer to the Appendix for an example of an OA.)

CHAPTER 12
GSA Rent Bills and Lease Costs

This page is intentionally left blank

GSA Rent Bills and Lease Costs

FBMS

- Regional Space Management Coordinators (SMC) must use FBMS to create, edit and manage all real estate contracts, including Service-direct Leases, GSA Occupancy and Department of Homeland Security (DHS) Agreements.
- The SMC must review all Regional rent and DHS bills (validated in FBMS) each month to ensure the proper rent and costs are assessed. This includes verification of the correct square footage and rent is applied; and released space is terminated, etc. In addition, SMC must certify monthly that all bills are accurate and corrections are noted and reported.

GSA Rent Bills Online

- The Space Management Coordinator can easily view the GSA rent bills online at <https://www.pbs-billing.gsa.gov/ROW/>. New users must download an application form from the website, complete it, obtain a supervisor's signature and fax it to GSA.
- GSA provides rent estimates 18-months in advance before changing the rent, including increases and decreases to the rent. This does not include operating or tax adjustment escalations.

GSA Rent Bill

- Rent is billed on the 15th of each month. If the FWS occupies the space between the 1st and the 15th of the month, the FWS is charged for that whole month. If the FWS occupies the space between the 16th and the 31st of the month, the FWS is charged the next month.
- **For example:** If the FWS occupies the space on July 12th, the first rent bill will be assessed as of July. If the FWS occupies the space on July 19th, the first rent bill will be assessed on as of August 1st.
- The total of the following line items on the GSA rent bill equal the Total Annual Rent:
 - Shell Rental Rate
 - General Purpose Space
 - Warehouse Space
 - Amortized Tenant Improvement
 - General Allowance Used
 - Amortization Term (in months)
 - Operating Costs
 - Real Estate Tax
 - Amortized Tenant Improvements
 - Customization Allowance Used
 - Adjustments for Additional Services
 - 24-hour Computer Room Operation
 - Adjustments for Reduced Services

- Parking
 - Structured
 - Surface
- Rent Charges for Other Space
- PBS Fee (GSA Fees)
- Pro Rata Joint Use Charges
- Lump Sum Adjustments
 - Overage to the Tenant Improvement Allowance
 - Forced Move Credits
 - Other Corrections for billing errors
- Reimbursable Services (Adjustments for One-Time Services)
- Antenna Bill

Shell Rent

- General purpose (office), warehouse, and parking are the three types of space that are charged shell rates on the GSA rent bill. GSA negotiates with the Lessor to provide a “warm lit” shell in office space. A “warm lit” shell includes the following:
 - Ceiling
 - Demising walls (perimeter and between tenants)
 - Floor (not floor covering)
 - Access and service capabilities needed to get into and occupy the space
 - Overhead lighting
 - Vertical and horizontal ductwork
- The following are not included in the “warm lit” shell rate. These items are included in the tenant improvement costs.
 - Internal subdividing walls
 - Wall or floor finishes
 - Cost of electricity
 - Information Technology and Telecommunication wiring and outlets
 - Special security and access control requirements

Amortized Tenant Improvements

- GSA calculates the Tenant Improvement (TI) allowance using a formula based on a national construction rate, locality factor, and an agency’s tier level (customization). The TI is amortized into the annual rent listed in the draft Occupancy Agreement. If the local FWS field office spends more than their designated TI, the overage amount must be paid by lump sum to GSA using an RWA. If the local field office does not spend their entire TI, the total annual rent can be lower than initially estimated. The final OA (as compared to the draft OA) should note the cost savings under the TI portion of the financial summary, which should match your rent bill.

- Space Coordinators need to request the original balance, term, and interest rate of the TI. GSA publishes an annual interest rate linked to the 10-year Treasury bond (see <http://www.treasury.gov/resource-center/data-chart-center/interest-rates/Pages/TextView.aspx?data=yield>) which is applied to GSA-owned buildings. The interest rate for GSA leased buildings is provided by the Lessor and potentially negotiated by GSA (if rate is unreasonable). This allows calculation of the monthly payment and balance. The remaining balance is owed if OA is terminated before the expiration date.

Operating Costs

- Operating costs can include such things as utilities, janitorial services, snow removal, landscaping maintenance, insurance, etc. In GSA occupied space the operating expenses are adjusted annually on the anniversary date of the Lease and passed through to the FWS. In Fiscal Year 2009, GSA implemented a 3% annual increase in operating costs on new Occupancy Agreements, which is initiated at the beginning of each Fiscal Year.

Real Estate Taxes

- The Lessor and GSA establish the percentage of occupancy for the government occupied space in the lease agreement. The base tax rate is included in the original rent rate. On each subsequent year of the lease, the real estate tax increase is paid to the Lessor according to the Government's percentage of occupancy of the building. GSA then passes this annual lump sum cost increase on to the FWS.

Overtime Services

- The cost of operating the building's services (HVAC, electrical, etc.) after the building's business hours. This cost is stated in the Lease or GSA Occupancy Agreement and is usually a cost per hour and paid lump sum using a recurring RWA. However, it can be negotiated into the rent bill.

Parking

- Parking rent is assessed per space, not per square foot. There are different charges for structured (inside) parking and surface (outside) parking.

Note: In some cases, GSA will not acquire parking through the lease process and FWS may have to acquire parking through a Service Contract.

Rent Charges for Other Space

- This charge is treated the same for both Federally-owned and leased space. This line item is used to charge for space types that have no square footage associated with them, i.e. ware yards, docks, and helipads.

Public Buildings Service (PBS) Fee

- As of FY 2008, GSA charged a standard 7% fee on non-GSA owned space for lease acquisition services, property management services, tort liability, catastrophe, contract formation, and indemnification for agencies from the risks of vacancy (120-day notice). In most cases a 2% discount is given to agencies for leased assignments in which GSA views the space to be non-cancelable. This fee is non-negotiable, whether the tenant agency is the COR or not.

Joint Use Space Charges

- Joint use space charges are rents and operating costs for specific space and amenities, including but not limited to cafeterias, Randolph Sheppard Act blind stands, daycare centers, fitness centers, locker rooms, conference rooms, mailrooms, and visitor parking. The costs for these amenities are summed up and distributed among all Federal users directly in proportion to each user's percentage of Federal occupancy. Joint use charges apply whether or not employees of the agencies elect to use the joint use facilities.

Lump Sum Adjustments

- These are adjustments made to the agency rent bills for back-billing corrections, tax adjustments, late operating cost adjustments, unique circumstances, forced move credits, or errors to the space assignment. It is important to check that we receive a credit billed at the holdover rate and then back-billed for the new lease rate.

Reimbursable Services

- These are adjustment charges for one-time services requested by FWS, i.e. integrated services, Federal supply services, Federal technology services, etc.

Antenna Bill

- An antenna is any device of the FWS located on a public building or on GSA-controlled land, which can be used to transmit and/or receive electromagnetic signals. A tower located on GSA-controlled land is not an antenna; however, equipment attached to that tower which fits the above description is an antenna for pricing purposes. GSA pricing policy applies commercially equivalent rent for antenna sites. These charges are generally applied to Federal occupied space. The antenna site rents are set for five-year terms, with no escalation in the rate.

R/U Factor

- The conversion factor that, when applied to usable area, gives the rentable area and is normally determined by the building owner and/or GSA. GSA charges rent according to the rentable square footage, not the usable square footage.
- 1,000 usable square feet × 1.15 R/U Factor = 1,150 rentable square feet
Common area = 150 square feet

This page is intentionally left blank

CHAPTER 13
Department of Homeland Security Costs

This page is intentionally left blank

Department of Homeland Security Costs

FBMS

- The Space Management Coordinator (SMC) must use FBMS to view, edit and reconcile all data.

Security Bill Charges

- Since 2004, GSA no longer includes security charges as part of the GSA rent bill. The Department of Homeland Security (DHS) assesses a base security fee to all GSA controlled facilities (leased and federally owned). You can access the DHS security charges through the GSA rent bill website. The following are the different types of security charges:
 - Basic Security Rate
 - The basic security rate is developed by DHS and approved by the Office of Management and Budget on a per square foot basis.
 - This charge is assessed to all GSA controlled facilities. DHS must receive OMB approval to increase and/or change this rate.
 - Security charges are subject to unilateral change by DHS.
 - Building Specific
 - Additional security charge for building specific security requirements, i.e. guard services, access control systems, security alarm systems, etc.
 - Security Bill Review
 - The Space Management Coordinator can view the security bills through the GSA Rent website at <https://www.pbs-billing.gsa.gov/ROW/>. The Space Management Coordinator must review all of the security bills for their Region monthly to ensure that the proper charges are assessed. (Refer to the Appendix for examples of the Security Bill.)

Security Requirements

- The FWS must coordinate with the local Federal Protective Service (FPS) office to determine any additional security needs for the facility. FPS will provide a security assessment for all GSA controlled facilities (leased and federally owned). The security assessment provides information on additional security requirements that could be needed and provided at the facility. (Refer to DHS ISC Standards and Requirements).

Security Work Authorization (SWA)

- The SWA works the same as the Reimbursable Work Authorization (RWA). The SWA is used to pay the FPS for security services and systems. (Refer to Appendix for an example of SWA.)
- The Space Management Coordinator must use FBMS to view, edit and reconcile data.

HSPD-12 Cards (a.k.a. Smart Cards)

- Homeland Security Presidential Directive 12 (HSPD-12) issued on August 27, 2004, directed agencies to issue a standard form of identification for all employees who fall under HSPD-12 requirements. The Department has contracted with the GSA to assist with HSPD-12 implementation and to issue standard ID cards. The ID card for the Department has been named DOI-Access (previously referred to as Smart Cards or Personal Identity Verification cards). The HSPD-12 card may also be used as proximity card to access secure facilities. The HSPD-12 card has the capability to allow access into facilities, personal computers and may be a replacement for Government credit cards in the future.

CHAPTER 14
Glossary

This page is intentionally left blank

Glossary – Acronyms

Acronyms Used in Space Management

ABAAS	Architectural Barriers Act Accessibility Standard
ADA	Americans with Disabilities Act
AFF	Above Finished Floor
ANSI	American National Standards Institute
AO	Administrative Officer or Accountable Officer
ARD	Assistant Regional Director
BAFO	Best and Final Offer
BMO	Budget Management and Operations Office
BOMA	Building Owners and Managers Association
BPN	Business Partner Network
BTU	British Thermal Unit
CA	Cooperative Agreement
CAF	Common Area Factor
CBD	Central Business District
CBR	Client Billing Record
CFM	Cubic Feet per Minute
CFR	Code of Federal Regulations
CGS	Contracting and General Services
CO	Contracting Officer or Certificate of Occupancy
COR/COTR	Contracting Officers (Technical) Representative
CPI	Consumer Price Index
DFM	Division of Financial Management
DHS	Department of Homeland Security
DM	Departmental Manual
DOI	Department of Interior
DUNS	Data Universal Numbering System
EIS	Environmental Impact Statement
EPA	Environmental Protection Agency
FAR	Federal Acquisition Regulation
FMV	Fair Market Value
FPS	Federal Protective Service
FRPP	Federal Real Property Profile

FTE	Full Time Employee
FWS	Fish and Wildlife Service
GSA	General Services Administration
GSAM	General Services Administration Acquisition Manual
GSAR	General Services Administration Acquisition Regulation
HSPD-12	Homeland Security Presidential Directive -12
HVAC	Heating, Ventilation, Air Conditioning
IA	Interagency or Intra-agency Agreement
IPAC	Intra-Governmental Payment and Collection
LCO	Leasing Contracting Officer
MOU	Memorandum of Understanding
OA	Occupancy Agreement
OMB	Office of Management and Budget
OPAC	On-Line Payment and Collection System
O/T	Overtime
PBS	Public Building Service (Branch of GSA)
PM	Property Manager
PNM	Price Negotiation Memorandum
PO	Purchase Order
POR	Program of Requirements
PR	Purchase Request
PSF	Per Square Foot
RDA	Rural Development Act
RLP	Request for Lease Proposal
RO	Regional Office
ROW	Rent on the Web
RPI	Real Property Inventory
RSF	Rentable Square Feet
R/U Factor	Rentable/Usable Factor
RWA	Reimbursable Work Authorization
SFO	Solicitation for Offers
SMC	Space Management Coordinator
SMNSO	Service Managed Not Service Owned
SMP	Space Management Plan
S/S	Slab-to-slab (partitioning)

STC	Sound Transmission Class
SWA	Security Work Authorization
TAS	Treasury Account Symbol
TI	Tenant Improvement
UFAS	Uniform Federal Accessibility Standard
UR	Utilization Rate
USF	Usable Square Feet
VCT	Vinyl Composite Tile
WO	Washington Office

This page is intentionally left blank

Glossary - Definitions

A

Accountability: Property accountability includes responsibilities for such tasks as tracking the movement of assets, recording changes in physical condition, and verification of physical counts. The property managers must exercise this responsibility and maintain proper control over an organization's assets through recordkeeping, effective policies and procedures, and appropriate security controls.

Accountable Officer: Accountable Officers are responsible for ensuring accountability of real property under their control and that accurate real property records are maintained. Accountable Officers are field office managers who have direct management oversight over the real property.

Accountable Real Property: Accountable real property assets are assets that are determined to be important because of their use, value, or significance in meeting the DOI's mission and fiduciary responsibilities.

Acquisition: Acquisition of real property within DOI occurs in many ways, including, but not limited to, leasing of existing or build to suit construction facilities, donation, transfer and land exchanges.

Acquisition Plan: It is the estimate of timeframes for various steps in the procurement process, from development of space requirements to occupancy.

Amortization: The process of retiring a debt or payment of tenant improvement alterations through systematic payments of rent.

Antenna/Satellite Dish Rates: GSA pricing policy applies commercially equivalent rent charges for antenna sites. These charges are generally applied to Federal occupied space. The antenna site rents are set for five year terms, with no escalation in the rate.

Architectural Barriers Act Accessibility Standards (ABAAS): Previously called the Uniform Federal Accessibility Standards (UFAS) and Americans with Disabilities Act (ADA): These are the accessibility standards that all space must meet throughout the building.

Award: After evaluation of the offers, a written award letter is sent to the successful offeror, including a copy of the lease agreement, stating the financial terms and conditions of the award. Issuance of the award letter constitutes a contractual agreement between the government and the prospective Lessor.

B

Best and Final Offer: Offerors' final offer submitted to the Leasing Contracting Officer for evaluation to award.

BOMA Usable Square Feet: Should be computed by measuring the area enclosed by the finished surface of the room side of the corridors (corridors in place as well as those required by local codes and ordinances to provide an acceptable level of safety and/or to provide access to

essential building elements) and other permanent walls, and the center of tenant-separating partitions. Building common areas are considered to be part of floor usable area. No deduction should be made for columns and projections necessary to the building. Where alcoves, recessed entrances, or similar deviation from the corridor are present, BOMA Usable Square Feet should be computed as if the deviation were not present.

Note: Over the years the term occupiable square feet, net usable square feet, and usable square feet have been used in leases, these terms are essentially the same as BOMA usable square feet.

BTU: Acronym for British Thermal Unit. Is the measurement that is used to determine the amount of heat that is produced per hour in order to determine the amount of cooling that will be necessary to achieve office standard temperature.

Build-to-Suit Lease: Refers to the situation in which a developer constructs a facility to a lessee's specifications.

Buildings: Buildings are defined as any structure with a roof and commonly enclosed by walls, designed for human occupancy, storage, or shelter for animals, distinguished from other structures not designed for occupancy (such as fences or bridges). Buildings include offices, warehouses, housing and storage units. Fixed equipment that is permanently attached to and a part of the operation of the building and cannot be removed without cutting into the walls, ceilings or floors is also included.

Building Management: The safeguarding of the agency's interest in leased property in an efficient and economical manner consistent with the best business practices.

Building Shell Rate: The shell rate is the portion of the overall rent being paid by GSA to the Lessor, which is attributable to the unfinished shell and structure of the space before being built out for a particular tenant needs. This includes the ceiling, demising walls, and floor, as well as the access and service capabilities needed to get into and occupy the space. The shell rate also includes overhead lighting and both vertical and horizontal HVAC ducting and piping, but not internal subdividing walls, wall or floor finishes, or the cost of electricity. The term "warm lit shell" is often used to describe the elements composing the shell rate as it will be used by GSA. General purpose, warehouse, and parking are the three types of space that are charged shell rates on the GSA rent bill.

The shell rate is derived by subtraction; after services (including taxes) and tenant improvement amortization are deducted from GSA's overall cost for the space, the remainder is the shell rate.

C

Capitalization: Is defined as recording the total acquisition cost of an item in the general ledger of DOI's financial accounts. The intent of capitalization in the financial records is to provide an accurate total reflection on DOI's investment in real property over time and to provide information on operating performance by allocating costs to the periods benefited.

Capital Improvements: Capital improvements are modifications to existing real property which (1) extend its useful life by 2 years or more or (2) enlarge or improve its capacity or otherwise upgrade it to serve needs different from, or significantly greater than, those originally intended.

Capital improvements which meet the general capitalization criteria are capitalized and recorded in the general ledger.

Capital Lease: Are leases that transfer substantially all the benefits and risks of ownership to the agency. If at its inception, a lease meets one or more of the following four criteria, the lease should be classified as a capital lease by the agency. If the lease does not meet any of the following criteria, it should be classified as an operating lease.

1. The lease transfers ownership of the property to the agency by the end of the lease term.
2. The lease contains an option to purchase the leased property at a bargain price.
3. The lease term is equal to or greater than 75% of the estimated economic life of the leased property.
4. The present value of rental and other minimum lease payments, excluding that portion of the payments representing the cost of services, equals or exceeds 90% of the fair value of the leased property.

Capital Lease (cont.): The last two criteria are not applicable when the beginning of the lease term falls within the last 25% of the total estimated economic life of the leased property.

CBD: Acronym for Central Business District. The area within a central city that encompasses the community's principal business and commercial activities, and the immediate fringes thereof, as geographically defined in consultation with local elected officials.

Ceiling High Partitions: Floor-to-ceiling walls used to divide space or provide acoustical control, providing no structural support to the building.

Certificate of Occupancy: is issued by the local building authority when a leased facility is complete and acceptable for occupancy.

Change Order: A change in the original plan of construction due to upgrading of material or the inclusion of additions.

Circulation: A percentage that is used to determine the amount of space that is required to have passage between workstations and partitioned areas in order to provide safe ingress and egress.

Client Billing Record (CBR): Is the number that GSA uses to identify an agencies space assignment for billing purposes.

Common Area: Usually includes a share of building support/common areas such as elevator lobbies, building corridors, and floor service areas. Floor service areas typically include restrooms, janitor rooms, telephone closets, electrical closets, and mechanical rooms. Common area space generally does include vertical building penetrations and their enclosing walls, such as stairs, elevator shafts and vertical ducts.

Cooperative Agreement: A legal instrument reflecting a relationship between the Federal Government and a State government, a local government, or other recipient when (1) the principal purpose of the relationship is the transfer of money, property (real or personal), services, or anything of value to the recipient to carry out a public purpose of support or stimulation authorized by Federal statute, and (2) substantial involvement between the parties is anticipated during

performance of the project. Cooperative Agreements are between a Federal Agency and a non-Federal entity (University, State, or Duck's Unlimited).

COR: The Contracting Officer's Representative serves as the eyes and ears of the Contracting Officer. Proper administration and management of the lease translates into better employee morale and holds Lessors accountable to provide the agency with the full value which was negotiated and agreed to in the lease contract.

The GSAR states that "COR means a Government employee designated in writing by the contracting officer, by name and position title, who is authorized to take action for the contracting officer with specified limitations. A contracting officer may not authorize a COR to issue change orders or otherwise modify a contract unless the COR is a warranted contracting officer."

D

Davis Bacon: All space acquisitions must use Davis Bacon wage rate determinations for cost figures.

Delegation of Leasing Authority: Upon request to GSA by an agency, delegation of leasing authority for that agency allows them to acquire and manage its own space for up to 20 years regardless of geographic location. All rules and principles, including those pertaining to prospectus preparation and submittal, apply to agency actions unless specifically exempted. Prior to instituting any action under a delegation, the head of a Federal agency or its designee must notify GSA of the agency's need for general purpose space and the agency's intent to exercise the authority granted in the delegation if GSA determines that suitable Government-controlled space is not available to meet the space need of the Federal Agency.

There are three types of delegation requests: categorical, general, and special purpose. The FWS does not use special purpose. Examples of Categorical: docks, depots, hangers, and mini-storage units. GSA delegation approval is not required for categorical. Examples of General: office, warehouse, laboratory, and housing. General purpose delegation requires GSA approval.

Delineated Area: The specific boundaries as determined by the bureau, office or Department, within which space will be obtained to satisfy the space requirement. It is based upon the agency's geographic service and mission, and the potential for competitive offers from the marketplace. It is described by streets, highways, or similar recognizable boundaries which, when all lines are connected, will form an enclosed area. The enclosed area must contain a large enough geographical area to provide adequate competition in the space acquisition process.

DUNS Number: The Data Universal Numbering System is maintained by Dun & Bradstreet, Inc., as a method to register and track American business and corporations. The GSA Form 3518 requires each offeror to provide a DUNS number. To be issued a DUNS number required the name and mailing address of the business including zip code, telephone number and name of business owner.

E

Easement: An interest in real property that conveys use, but not ownership.

Escalation Clause: A clause in an agreement that provides for the adjustment of a price or rent based on some event or index.

Evaluation of Offers: Evaluates both the technical and price aspects of the proposals.

Executive Orders and Regulations:

1. Code of Federal Regulations, 41 CFR 101-17 through 21, and 41 CFR 102-71 through 74, and 78 through 83, and 85.
2. Department Manual 425 DM 1 through 6.
3. The Rural Development Act, Farm Security and Rural Investment Act of 2002, Public Law 107-171.
4. Executive Order 12072, Federal Space Management – Central Business Area.
5. Executive Order 13006, Locating Federal Facilities on Historic Properties in Our Nation's Central Cities.
6. Executive Order 13327, Federal Real Property Asset Management
7. Executive Order 13423, Strengthening Federal Environmental, energy, and Transportation Management.
8. Executive Order 12941, Seismic Safety of Existing Federally Owned or Leased Buildings.
9. Executive Order 12699, Seismic Safety of Federal and Federally Assisted or Regulated New Building Construction.
10. Randolph Sheppard Act: vending facilities for the blind in Federal Buildings. All requirements necessary for the disabled-provided vending space is included in the lease package. The agency pays the cost of the space that the vending space occupies.
11. Davis Bacon Act of 1931 as amended
12. Architectural Barriers Act Accessibility Standard (ABAAS)
13. FWS Manual – FW 370, Parts 1-3.

Expansion: Space acquired in addition to the amount of space occupied and agreed to under an existing lease.

F

Failure in Performance: The Lessor has failed to provide a lease required service, maintenance, utility, or alteration. Under the term of the lease agreement the government has the right to complete the action and deduct the cost from the rent.

Fair Market Value: The estimated price that both a buyer and seller would willingly agree to when neither party is under undue pressure to complete the transaction.

FBMS: The Department of Interior has deployed a unified system known as the Financial and Business Management System (FBMS) in order to provide a unified approach for conducting business in order to more effectively use its resources and serve the American public. FBMS eliminated more than 80 Department- and bureau-specific systems. By eliminating these systems, the Department will consolidate and integrate multiple functional areas such as finance, federal aid, contracting and asset management into one system.

Federal Real Property Profile (FRPP): The single, comprehensive, and descriptive database of all real property under the custody and control of all executive branch agencies (owned and leased), except when otherwise required for reasons of national security, in accordance with

Executive Order 13327. Memorandum of Understandings and Interagency Agreements are recorded, but not tracked.

Fed Biz Ops: Federal Business Opportunities is the single government point-of-entry for Federal government procurement opportunities over \$25,000.00. Commercial vendors and Government buyers are invited to post, search, monitor, and retrieve opportunities solicited by the entire Federal contracting community. The website is www.fbo.gov.

Final Inspection: After the space is completed it is inspected to ensure that all the terms and conditions of the lease and the final space layout drawings have been provided.

Fixed Equipment: The equipment is permanently attached and a part of the operation of the building and cannot be removed without cutting into walls ceilings or floors. Examples of fixed equipment include but is not limited to cabinets, locks, lab equipment, security systems, telephone and data wiring, plumbing, heating and lighting, elevators, central air conditioning systems, and built in safes and vaults.

Fixed Expenses: Operating expenses that generally do not vary with occupancy and which prudent building owners will pay whether the property is occupied or vacant. Usually refers to insurance and real estate taxes.

Flood Plain: Requirements are located in Executive Order 11988. The government is prohibited from acquiring space located within a 100-year flood plain. Flood plain maps may be purchased from USGS mapping services at 1-800-358-9616. Each proposed site should be checked against the floor plain maps to ensure that it is not within a 100-year flood plain.

Foot-candles: The illumination on a surface one square foot in area on which there is a uniformly distributed flux of one lumen, or the luminance produced on a surface all points of which are at a distance of one foot from a directionally uniform point source of one candle. The measurement used to determine the amount of light required at a specific height.

Forced Move: The involuntary relocation of a tenant from one space assignment to another, which is initiated by another agency tenant or GSA.

G

General Purpose Space: All types of space other than “warehouse”, “parking”, or “unique” space, as defined elsewhere in this glossary.

Greening of Buildings: Energy efficient management and sustainability will be part of integrated programming and project planning with respect to space management activities. These efforts place emphasis on energy- and water-efficient design and fixtures; use of low emitting and less toxic materials; use of resource efficient and environmentally preferable products; waste minimization and recycling; green cleaning and other environmentally optimized practices.

GSA Controlled Space: Space under the custody or control of GSA. This includes leased and space in Federal Buildings.

GSA Leasing Clause Forms include:

1. GSA Forms 3516, Solicitation provisions – explains to the offerors how to offer.

2. GSA Form 3517, General Clause – applicable GSAR and FAR leasing clauses.
3. GSA Form 3518, Representations and Certifications – requires offeror to certify certain requirements about the offeror.

H

Historic Preference: Requirements are located in Executive Order 13006. Preference will be given to offers of space in buildings on or formally listed as eligible for inclusion in the National Register of Historic Places and to historically significant buildings in historic districts listed in the National Register. Buildings offered must meet the terms and conditions of the SFO.

HVAC: Acronym for heating, ventilation and air conditioning system.

I

Indemnification Fee: A portion of the “GSA Fee” that is charged to agencies for the indemnification from the risks of vacancy (120-day termination rights).

Interagency Agreement: Interagency Agreements are entered into and signed by an agency to the lease contract firm term. Interagency Agreements are between different agencies (DOI and HUD). All known terms of the sharing of the space are specifically outlined in the Interagency Agreement. As changes are made to the occupancy of the space, the Interagency Agreement should be amended. The Interagency Agreement becomes the basis for the IPAC billing for the cost of the space during the term of the lease agreement. There are several different formats for the Interagency Agreements, contact the Contracting Officer for samples and specific Interagency Agreement formats. Percentage of occupancy for each agency is calculated by amount of space occupied not by personnel head count.

Intra-agency Agreement: Intra-agency Agreements are entered into and signed by an agency to the lease contract firm term. Intra-agency Agreements are between different bureaus of an agency (FWS and BOR).

IPAC: Interagency Payments and Collections. This is the billing and collection system that is used by agencies to transfer funds for services rendered or received.

J

Joint Use Space: Joint use space charges are rents and operating cost for specific amenities, including but not limited to cafeterias, Randolph Sheppard act blind stands, daycare centers, fitness centers, conference rooms, and visitor parking. The costs for these amenities are computed and distributed among all Federal users directly in proportion to each user’s percentage of Federal occupancy. Joint use charges apply whether or not employees of the agencies elect to use the joint use facilities.

L

Lease: A contract which sets forth certain rights and responsibilities of the parties through which an owner of an asset (the Lessor) conveys the right to use its asset to another party (the lessee)

for a specified period of time (the lease term) for specified periodic payments. (SF-2 is used for the first two pages of the lease.)

Lease Extension: A modification to the lease agreement that adds additional time to the expiration date of the lease.

Lease Modification: An amendment to a lease by mutual agreement of the Lessor and lessee, adding or changing one or more of the terms and conditions of the lease. Lease modifications are completed with a Supplemental Lease Agreement (GSA Form 276).

Leasing Contracting Officer: A contracting officer has authority to enter into, administer or terminate leases (contracts) and make related determinations and findings. A contracting officer may bind the Government only to the extent of the authority delegated to him/her/them.

The Leasing Contracting Officer (LCO) must meet the requirements for warrant as stated in the Department of the Interior, Contracting Officers Warrant System Manual. The warrant is issued in writing by each agency on a case-by-case basis. The warrant is issued to the person not the position. Because the Federal Government is structured by a system of delegated powers, the authority transferred to line contracting officers is limited and specific. Leasing Contracting Officers continuing education requirement is 40 hours every 2 years.

Lessee (Tenant): One who possesses the right to use or occupy a property under a lease agreement.

Lessor: One who holds title to and conveys the right to use and occupy a property under lease agreement.

Lessor's Property Manager: This is the Lessor's Building Manager and/or building maintenance staff that are in charge of day to day building operations.

Lump Sum Payment: A payment made for space related services or tenant improvements not amortized in the rent.

M

Maintenance: A property is kept in condition to perform its function efficiently. Maintenance does not extend the useful life of the property or increase the value.

Market Survey: In order to maximize competition, a physical inspection is conducted of all properties or sites which have been offered for lease in response to an advertisement for space. If the space requirement is small and can be procured using expedited leasing procedures then the field survey of the area under consideration is conducted soliciting existing space for a the specific space requirement. If no existing space is available, then information on market conditions and the availability of suitable sites will be gathered for soliciting.

Measurement of Space: DOI recognizes the BOMA (Building Owners and Managers Association) International standard (ANSI/BOMA Z65.1-1996) definition for Office Area, which means the area where a tenant normally houses personnel and/or furniture, for which a measurement is to be computed.

Memorandum of Understanding (MOU): A written agreement between the FWS and another entity(ies) that confirms the use of cooperative policies or procedures to promote mutual endeavors. It is a non-funding document and can be signed by the Regional Director or other responsible party.

Moving Expenses: Whenever an agency or bureau relocates to new space, the agency or bureau pays all costs of the relocation, including furniture, data, and telephone.

N

Negotiations: The discussion between the Leasing Contracting Officer and all potential offerors to provide an opportunity to make changes to their offer and to ensure that their offer is complete.

Net Lease: A lease in which the tenant pays all the property charges (operating costs, real estate taxes, insurance, alterations, etc.) in addition to the rent.

Non-Cancelable Space Agreement: Any time an agency requests space which requires a high degree of specialized built out, or is in an area which could not be readily backfilled by GSA, the agency is asked by GSA to sign a non-cancelable occupancy agreement. The agreement states that if the agency vacates part or all of the space prior to the expiration of the firm term of the lease agreement, the agency will assume the entire financial responsibility for the leased space until GSA can terminate the lease agreement.

Novation Agreements: A novation agreement and accompanying supplemental lease agreement are executed when a change of property ownership occurs between the current Lessor and a new Lessor. Outright purchase, bankruptcy, or foreclosure is among the more common reasons for change of ownership. A warranty deed, a public trustee's deed, or whatever legal instrument that was used to transfer the property's ownership is necessary to initiate the novation process. The novation agreement is prepared in accordance with FAR 42.12. The novation document requires signatures from the current (old) and the new ownership. The supplemental lease agreement which actually accomplishes the novation is prepared in the name of the new ownership only.

O

Occupancy Agreement: The formal written agreement between GSA and the agency or bureau defining the financial terms and conditions for the occupancy of GSA controlled space. The agreement is signed by both parties.

Office Area: The area where a tenant normally houses personnel and/or furniture, for which a measurement is to be computed (BOMA).

Open Office Space: A space with no permanent partitioning is an open office space.

Operating Expenses: Expenses that include the base operating costs for a standard level of services for the government premises are operating expense. These expenses can include such things as utilities, janitorial, snow removal, landscaping maintenance, insurance, etc. In GSA occupied space, the operating expenses are adjusted annually and passed through to the

Overtime Services: The cost of operating the building's services (HVAC, electrical, etc.) after the building's business hours. This cost is stated in the Lease and is usually a cost per hour and paid lump sum by the agency or bureau.

P

Parking: Surface land, structures, or areas within structures designed and designated for purpose of parking vehicles.

PBS/GSA Fee: GSA charges a standard 7% fee for lease acquisition services, property management services, tort liability, catastrophe, contract formation, and indemnification for agencies from the risks of vacancy (120-day notice). A 2% discount is given to agencies for leased assignments in which GSA views the space to be non-cancelable.

Price and Cost Analysis: Price Analysis is the process of evaluating the proposed total price (rent) without regard to individual cost elements or proposed profit. Cost Analysis is the review and evaluation of the separate elements and profit in an offeror's proposal.

Price Negotiation Memorandum (PNM): At the conclusion of negotiations, a synopsis of the principal elements of the price negotiation is prepared and maintained in the lease file. At a minimum, the PNM must contain the following information:

1. Purpose of the negotiation
2. Description of the acquisition, which includes identifying solicitation number, name, position, and organization of each person representing the contractor and the government in negotiations.

The Contracting Officer signs and dates the PNM before the award. In the event of a dispute after the award, the PNM is considered the definitive source documenting the intent of all parties participating in negotiations. The PNM should clearly illustrate topics discussed, areas of disagreement, methods employed to reach consensus, and the final negotiated agreement.

Procurement Integrity: Procurement integrity must comply with FAR 3.104. As a rule, government employees must not solicit, discuss, or accept an offer or promise of future employment or business opportunity with anyone directly or indirectly associated with a competing contractor; discuss or accept any money, gratuity, or other thing of value from anyone associated with a competing contractor; and disclose any procurement proprietary or source selection information to anyone other than a person authorized by the contracting officer.

When sharing any procurement information with any government person, the CO should inform the government employee of the proprietary information that is being shared and ask each person to sign a form stating that they are aware of the restriction and agree to not divulge any of the information.

Progressive Occupancy: Acceptance of the space in incremental portions is progressive occupancy.

Prospectus: This is a detailed planning report prepared by GSA, in conjunction with the agency, in order to obtain Congressional approval of any leasing action which has an annual rent, excluding service and utilities, as adjusted annually in accordance with 40 U.S.C.606(f). The DOI delegation of authority contains this condition.

The Prospectus document is submitted to OMB and Congress to obtain authority to proceed with major leasing, construction, or repair and alteration projects. All FWS prospectus level projects, under the DOI delegation of space leasing, must be submitted, by the FWS GSA.

Protest: When the private sector disagrees with a procurement element of the space acquisition, they file a complaint.

Punch List: During the final space inspection, a list is made of all outstanding services/items, which have not been provided, installed, or finished. The detailed list of deficiencies is mailed to the Lessor and states a final date for the resolution of all outstanding items. The Government is not obligated to occupy the space until all deficiencies are satisfactorily resolved.

R

Radon Testing: Radon is a toxic gas. Testing is required in all government occupied spaces to ensure that radon levels do not exceed EPA standards. The appropriate clauses must be included in all lease agreements.

Randolph Sheppard Act: This Act requires that disabled persons receive the opportunity to operate vending or small commercial facilities in government occupied buildings. All requirements necessary for the disabled provided vending space is included in the lease package. The agency pays the cost of the space that the vending space occupies.

Real Estate Taxes: The locally assessed tax cost is adjusted in lease agreements annually and passed through to the agency or bureau based on the percentage of government occupancy.

Real Property: Land together with the permanent improvements (buildings, structures, and site improvements), located thereon.

Real Property Inventory (RPI): Maintenance tracking system by the Refuges Program to track maintenance on real property to collect fees for maintenance costs.

Reimbursable Work Authorization: GSA Form 2957 is the Reimbursable Work Authorization form that agencies use to transmit a lump sum payment to GSA for above standard items, alterations, and/or overtime services. There are two types of RWAs: Recurring and non-recurring.

Recurring RWAs are used for continual overtime services on an annual basis. The overhead fee on a recurring RWA is a flat \$100.00.

Non-recurring RWAs are used for alterations projects or one-time services needed in a space. The overhead fee is 12 percent (8% regional and 4% national added together).

Rent Appeal: Any appeals to your rent bill must be sent to GSA for evaluation. This does not include rent adjustments.

Rent Bill (OA Billing) Adjustments: These are adjustments made to the agency rent bills for corrections, unique circumstances, or errors to the space assignment.

Rent Concessions: Discounts or other benefits paid by the landlord to the tenant, usually in the form of additional tenant improvements, moving allowances, or free rent.

Rentable Square Feet: Rentable space is the area for which a tenant is charged rent. It is determined by the building owner and may vary by city or by building within the same city. The rentable space usually includes a share of building support/common areas such as elevator lobbies, building corridors, and floor service areas. Floor service areas typically include restrooms, janitor rooms, telephone closets, electrical closets, and mechanical rooms. The rentable space generally does include vertical building penetrations and their enclosing walls, such as stairs, elevator shafts and vertical ducts. Presently all GSA Public Buildings Service Bills for Space and Services are calculated in rentable square feet therefore in order to determine the BOMA usable square feet of the space, a calculation is required. Since each building has a unique conversion factor (R/U ratio) the GSA rental billing gives the conversion factor necessary for the space calculation and/or the amount of Common Space that is included in the Rentable square footage.

Rentable/Usable (R/U) Ratio and Common Area Factor: The conversion factor, when applied to usable area, gives the rentable area and is usually determined by the building owner and/or GSA.

Request for Lease Proposal: A document used by GSA to solicit for space which includes agency requirements and minimum standards; applicable Federal laws and regulations; and level of required services.

S

Schedule of Periodic Services: This is a schedule of all services provided daily, weekly, bi-weekly, monthly, semi-annually, annually, and at specific periods as required by the lease agreement. The schedule is used by the COR to administer the services requirements of the lease.

Security Charges: A security charge is assessed in all GSA controlled properties both leased and government owned, where the Federal Protective Service (FPS) provides security services. The annual rate is developed by FPS and approved by the Office of Management and Budget on a per square foot basis.

Seismic Safety: Standards that ensure building safety during seismic events such as earthquakes. Testing is required in all government occupied spaces to ensure that proper seismic standards have been met. The appropriate clauses must be included in all lease agreements.

Service First: Is a concept with the goals to achieve dramatic increases in Customer Service, Operational Efficiency, and Quality of Resource Stewardship. To accomplish this mission reliance will be made on combined strengths. The agencies are to be partners in providing better and more convenient service and to share resources for more cost-effective delivery of services. It is about working together doing the right thing, in the right place, at the right time.

Service Managed Not Service Owned: Is space that we acquire through an Interagency or Cooperative Agreement that the Service may manage and control its day-to-day use, but does not own. These formal Agreements must also acknowledge responsibility for maintenance and repairs.

Slab-to-Slab Partitions: Partitions that are constructed from the cement slab (floor) to the bottom of the next slab (floor). These types of partitions are constructed to provide security, sound conditioning, and/or to support the rest of the building.

SMART Card: Proximity card access system that will be used by DOI to secure all facilities. The SMART Card system accepts a multi-tasking card that will be programmed with a computer chip for desired tasks. The system will have future capabilities of being programmed to allow any Bureau employee access to facilities; in addition the system will eventually be used for personnel computer access and replacement for government credit cards and as government identification.

Solicitation for Offers (SFO): A document used by GSA to solicit for space; which includes agency requirements and minimum standards; applicable Federal laws and regulations; level of required services. Recently replaced with new system for Request for Lease Proposal (RLP).

Space Planning: The process of using recognized professional techniques of programming, planning, layout, and interior design to determine the best internal location and the most efficient configuration for satisfying agency space needs.

Space Requirements: A summary statement of an agencies space needs. These requirements will generally include information about location, square footage, construction requirements, and duration of the agency's space needs.

Special-Purpose Property: A limited-market property with a unique physical design, special construction materials, or a layout that restricts its utility to the use for which it was built.

Space Requirements Questionnaire: A questionnaire that provides information in a question/answer format to help determine space requirements.

Specifications: Written instructions to the builder that contain all necessary information pertaining to dimensions, materials, workmanship, style, fabrication, colors, and finishes.

Standard Form 81, Request for Space: The written request for space from an agency, indicating the amount, type, location, and configuration of space required.

Statement of Fact: This statement provides a chronological history of the lease. A Statement of Fact is prepared by the Contracting Officer when the Lessor requests an estoppel agreement. The Statement of Fact recites the terms of the lease agreement and any supplemental lease agreements and includes but is not limited to: the amount of space covered, the date and length of the lease term, the amount of rental payments, Supplemental Lease Agreements, termination rights, if any, and renewal terms if any.

STC: Acronym for Sound Transmission Class (Formerly: Sound Transmission Coefficient). The term is used to measure the ability of a barrier to stop sound from passing through it.

Substantially Complete: When the work, the space, and all other things necessary for the government's access to the premises and occupancy, possession, use and enjoyment, as provided in the lease, have been completed or obtained, excepting only minor matters, this phase is substantially complete.

Succeeding Lease: This is a lease for continued occupancy of space under an expiring lease agreement. A new lease for the same location is completed upon the expiration of the old lease.

Superseding Lease: When the requirements of an agency make it necessary to negotiate numerous or substantial changes to an existing lease, consideration should be given to negotiating a superseding lease that would replace the existing lease. One of the terms of a superseding lease is the termination by mutual agreement of the prior or original lease.

Swing Space: Space that an agency occupies temporarily, usually while its long-term leased space is rehabilitated or modernized.

T

Tenant Improvement Allowance:

1. **General:** The tenant general component is a dollar amount per square foot set to cover the cost of typical ratios of normal office space finish components, such as doors, partitions, carpeting, electrical and telecommunications outlets (often known as standard “work letter” items). This allowance is set nationally by GSA, adjusted annually, and indexed to local construction costs.
2. **Customized:** Is set nationally by GSA, adjusted annually, and indexed to local construction costs. It varies, however, according to the particular agency or bureau for who space is being provided. The intent of this component is to cover special items, preparation, or finishes which are not typical to all office space, and are necessary to customize the space for that particular tenant. Each agency and bureau customization allowance is based on the average mix of space types throughout their entire occupancy in GSA’s inventory.

Termination for Default: The Lessor has caused the premises to become untenable and the Leasing Contracting Officer may consider termination of the lease. This action has serious legal ramifications and the Leasing Contracting Officer must contact the Solicitor before taking any action. Detailed documentation is required demonstrating the cause for termination could not have been corrected under the rights acquired by the government under the Failure in Performance Clause.

U

Usable Space: Spaces of a building that can be assigned to a specific tenant. Refer to glossary entry “BOMA Usable Square Feet” and GSA PBS “National Business Space Assignment Policy” May 2009.

Utilization: Utilization is the manner and the degree of efficiency with which Government-owned and leased facilities are occupied.

Utilization Rate (UR): The utilization rate is a space efficiency index derived by dividing the personnel housed into the BOMA usable square feet. The UR for office space is determined by dividing the total BOMA usable square feet of office space by the total full time employees. The maximum utilization rate for all DOI agencies is 200 BOMA usable square feet per person. The 200 BOMA usable square feet per person includes all individual and shared space such as

workstations, circulation, storage, conference space, and private offices. Exclusions may include warehouses and special space such as libraries, laboratories and evidence rooms.

V

Vacant Premises Adjustment: Provides for a reduction in the rental rate if the government vacates all or a portion of the leased premises before the expiration of the firm term. The vacant premises rate is intended to reflect the amount of the services that would not be needed if the space was vacant, i.e. janitorial services. If a portion of the space is vacated it should be a “leasable block”. The paragraph can be implemented if the original lease contract established a vacant premise rate. The amount of the vacant premises rate is established in the SF2 portion of the lease.

Variable Expenses: Operating expenses that generally vary with the level of occupancy or the extent of services provided. Usually refers to management, administration, utilities, cleaning, repair, and maintenance expenses.

W

Warehouse Space: Space, which is contained in a structure primarily intended for the housing of files, records, equipment, or other personal property, and is not intended for housing personnel and office operations.

120-Day Notice: When an agency determines it no longer has use for space and wishes to vacate the space, must give a minimum of 120-day notice to GSA. The notification of release must be written and must also specify the anticipated date of release. The space that is being relinquished must be a leasable block of space. The agency is responsible for all space charges until the date of release or until the date the space is actually vacated, whichever is later.

5-year plan: The FWS 5-Year Space Management Plan provides a framework, strategic vision and plan of action for effective bureau space management. It will be a dynamic document to be used by bureau management for implementing bureau space goals, including consolidation, collocation and disposal. The Department will develop a multi-year strategic plan, based on the bureau 5-Year Space Management Plans, to ensure that facility acquisitions, lease renewals and relocations are driven by mission-related needs. Priority will be placed on collocation, consolidation and improved partnership relations. Using information provided by the bureaus on current and future year lease plans, anticipated lease expirations, renewals, and relocations, the Department will help the bureaus to identify opportunities for collocation, consolidation and other actions to improve space utilization and mission support.

This page is intentionally left blank

CHAPTER 15
Appendix

This page is intentionally left blank

The following Appendix items will be included on the WO-CGS Intranet:

- FWS Space Utilization Memorandum
- Delegation of Leasing Authority – Memo to Regions (FMR Bulletin 2008 – B1)
- Lease Checklist
- Request for Lease Proposal (RLP) R101
- SF 81 – Request for Space
- Reimbursable Work Authorization (RWA)
- GSA RWA Frequently Asked Questions
- Security Work Authorization (SWA)
- Determining Capital Lease versus Operating Lease
- Waiver of Restoration
- Occupancy Agreement (OA) Sample
- Rent Bill Example
- Security Bill Sample
- Punch List
- GSA Move Cost Tool & Move Checklist
- Space Requirements Calculator
- Prospectus Lease Space Requirements Calculator
- Cost Per Person Model Instructions
- 2006 Cost Per Person Model User Manual
- Key Websites

This page is intentionally left blank