



UNITED STATES DEPARTMENT OF COMMERCE  
National Oceanic and Atmospheric Administration  
NATIONAL MARINE FISHERIES SERVICE  
Silver Spring, MD 20910

MEMORANDUM FOR: David Bernhart,  
Assistant Regional Administrator for Protected Resources  
NOAA Fisheries Service, Southeast Regional Office

FROM: Jamie Schubert, Marine Habitat Resource Specialist  
NOAA Restoration Center

DATE: July 7, 2015

SUBJECT: DWH-ERP-Request for section 7 Endangered Species Act  
Informal Consultation for *Deepwater Horizon* Oil Spill Phase IV  
Early Restoration Plan project *Texas Rookery Islands*

The National Oceanic and Atmospheric Administration (NOAA) Restoration Center requests informal consultation with your office, under section 7 of the Endangered Species Act (ESA), for impacts from the Texas Rookery Islands Project. This project has multiple components located on the following islands : 1) Rollover Bay, 2) Dickinson Bay II, 3) Smith Point and 4) Dressing Point. This project has the potential to affect the following federally listed species administered by NOAA Fisheries:

Sea Turtles (Green-T, Hawksbill-E, Leatherback-E, Loggerhead-T, Kemp's ridley-E)

The NOAA Restoration Center, a Lead Federal Agency, is requesting consultation on behalf of the Natural Resource Trustees for *Deepwater Horizon* Oil Spill. Please find Biological Evaluation forms for this Phase IV Early Restoration Project (multiple locations) included with this memo. It is our expectation that the proposed projects will have a significant net benefit to the Gulf of Mexico ecosystem.



## **Endangered Species Act Biological Evaluation Form** ***Deepwater Horizon Oil Spill Restoration***

Fish and Wildlife Service & National Marine Fisheries Service

### **Texas Rookery Islands Project (Smith Point Island)**

#### **Section A. Project Identification**

*Lead Agency Agency Contact Person*

U.S. Fish and Wildlife Service/National Marine Fisheries Service

*Agency Contact Person*

Ashley Mills and Laurel Jennings

*Phone*

812-756-2712 and 206-526-4601

*Email*

Ashley\_Buchanan@fws.gov and Laurel.Jennings@noaa.gov

I. Applicant Agency or Business Name

Texas Parks and Wildlife Department (TPWD)

II. Applicant Contact Person

Angela Schrift

III. Phone

512-389-8755

Email:

Angela.Schrift@tpwd.texas.gov

IV. Project Name and ID# (Official name of project and ID number assigned by action agency)

Texas Rookery Island Project – (Smith Point Island)

V. Project Type

Other

VI. NMFS Office (Choose appropriate office based on project location)

NMFS Southeast Regional Office

- VII. FWS Office (Choose appropriate office based on project location)  
Texas Coastal Ecological Services Field Office, Houston, TX

### **Section B.**

- I. Project Location  
Smith Point Island lies approximately 1.25 miles west of Smith Point peninsula. The island is located between Trinity Bay and East Bay within the Galveston Bay System.
- II. State & County/Parish of Project Site  
Galveston County, Texas
- III. Latitude & Longitude for Project Site (Decimal degrees and datum [e.g., 27.71622°N, 80.25174°W NAD83] [online conversion: <http://transition.fcc.gov/mb/audio/bickel/DDDMSS-decimal.html>])  
29.5363° N, 94.8087° W; NAD83
- IV. Township, range and section of the project area  
Texas does not use the public land survey system.

### **Texas Rookery Islands Project (Smith Point Island)**

#### **Section C. Description of Action Area**

The site is Smith Point Island. Smith Point Island lies on the upper Texas coast within Galveston Bay (Figure 1). The island lies just southwest of Smith Point Peninsula (Figure 2) that separates Trinity and East Bay. The relationship of the island to the peninsula is shown in Figure 3. The island is currently between 3 and 4 acres in size. It has eroded substantially in recent decades and now minimally supports colonial nesting waterbirds (Figure 4). The island is managed by Audubon Texas under a lease agreement with the Chambers-Liberty Counties Navigation District. The project proposes to enlarge the island using earthen fill, add or enhance armored protective features such as breakwaters or shoreline armoring, vegetate the island with desirable scrub-shrub plants, and enhance the existing emergent reef island component (Figure 5). The purpose of these actions is to provide habitat that will support colonial nesting waterbirds.

The majority of construction activities would take place on the island. Sources of fill material would be obtained from offsite. Locations would potentially include a direct dredge borrow source (Figure 7), , beneficial use material from the Mid-Bay Reach of the Houston Ship Channel (Figure 7), or an undetermined upland offsite borrow site. Temporary access channels may be constructed in order to access and transport the fill material. Indirect and temporary effects would take place with boat ramps, navigation channels, staging areas, and potentially with local recreational users.

**#1 Attach a separate map delineating where the action will occur.**

(See attached Figures 1-9).

**#2 Describe ALL areas that may be affected directly or indirectly by the Federal Action and not merely the immediate project site involved in the action, or just where species or critical habitat may be present. Provide a description of the existing environmental conditions and characteristics (e.g., topography, vegetation type, soil type, substrate type, water quality, water depth, tidal/riverine/estuarine, hydrology and drainage patterns, current flow and direction), and land uses (e.g., public, residential, commercial, industrial, agricultural).**

The majority of the action area is identified in Figures 6 and 7. Smith Point Island lies approximately 1.25 miles west of Smith Point peninsula. The island is located between Trinity Bay and East Bay within the Galveston Bay System at: 29.5363° N, 94.8087° W; NAD83. The existing island is shown in Figure 4.

Figure 7 shows the location of the island, potential borrow source area, Smith Point peninsula, and navigation channels. Figure 8 shows the preliminary restoration design and the known oyster reef, oyster leases, and pipelines in the area.

The community of Smith Point which is located on the nearby Peninsula (not the island), contains homes and structures, commercial facilities, recreational vehicle parks, docks and marinas, a local park (Robbins Park) and Candy Abshier wildlife management area (Figure 3). This community may be impacted by noise, additional use of the boat docks, and additional personnel passing through the area.

See below for detailed descriptions of the action area

Existing Environmental Conditions and Characteristics

*Substrate type, Topography, and Soils*

Smith Point Island is comprised of intertidal and supratidal habitat. Smith Point Island was likely a natural reef island associated with a suite of reef islands mapped in 1921 by NOAA (Figure 9). In 1950, material was added to the islands current location when the Channel to Smith Point was constructed. The island may have received additional material in 1972. The island is currently comprised of winnowed oyster shell that was left behind after the lighter dredged sediments eroded away. The submerged bay bottom surrounding the island is primarily composed of clays with some silt, scattered shell, active oyster reef, and hard bottom substrate (Figure8). The depths surrounding the island are relatively shallow between 0 and 5 feet.

The project may use sediments from one of several sources and thus affect those potential source areas. These include a suitable site within the borrow source area, beneficial use of dredged material from a reach of the Houston Ship Channel (Figure 7), or earthen fill associated with an upland borrow site. This borrow source area is comprised mainly of clayey silt. The Houston Ship Channel sediments would vary but would include substantially more silts and sands.

### *Existing Vegetation Type*

The island was created primarily by the deposition of dredged materials. Over time, much of the sediment has eroded away leaving primarily winnowed oyster shell. The shell is continually moved by wave energy limiting the extent of vegetation establishment. In the areas which vegetation exists, it is primarily comprised of tamarisk (*Tamarix* sp.) salt cedar shrubs and limited herbaceous vegetation including sea purslane (*Salicornia* sp.) and seaside tansy (*Borrchia* sp.) which can tolerate the salinity exposure.

The island is currently classified under the Cowardin classification system as Estuarine Intertidal Reef. Surrounding the island are large areas of Estuarine Subtidal Reef (a.k.a oyster/shell reef) habitat as well.

### *Water Quality, Water Depth, Tidal/Riverine/Estuarine, Hydrology and Drainage Patterns, Current Flow and Direction*

The depths surrounding the island are relatively shallow ranging to a depth of approximately 3 feet in the surrounding area and up to 5 feet in the nearby navigation channel. The hydrology of the area is affected by tidal actions and by freshwater inflows from the Trinity and San Jacinto Rivers. Tidal currents are fairly strong as water moves between Trinity Bay and East Bay. High flow pulse events associated with the river's discharge can overwhelm tidal currents. Wind speed and direction within the Galveston Bay System also plays an important role in affecting tide elevation. It can dampen or enhance the height of waves as well as their potential energy.

According to the water quality index, Galveston Bay received a poor rating. Galveston Bay is rated fair for dissolved inorganic nitrogen concentrations and rated poor for dissolved inorganic phosphorus concentrations. Thirteen percent of the estuarine area was rated poor for dissolved inorganic nitrogen concentrations, whereas 68% of the estuarine area was rated poor for dissolved inorganic phosphorus concentrations. Expectations for water clarity are similar to those for normally turbid estuaries, with water clarity rated poor at a sampling site if light penetration at 1 meter was less than 10% of surface illumination. Dissolved oxygen conditions in Galveston Bay are rated good (U.S. EPA 2007).

Due to the accumulation of dioxins and PCBs in catfish, the project area has a consumption advisory (#50) for all species of catfish. (Accessed 9 March 2015)

<http://www.dshs.state.tx.us/seafood/Survey.shtm#advisory>

### *Land Uses*

Smith Point Island is managed by Audubon Texas through a lease with the Chambers-Liberty Navigation District. Any additional lease(s) for managing the submerged bay bottom and the construction activities would be obtained by the project manager prior to implementing the proposed restoration. Audubon Texas manages the island for nesting colonial waterbirds. Activities performed by Audubon Texas include monitoring, predator control, and educational signs to reduce disturbance. Adjacent submerged lands are being used to harvest oysters. Figure 8 shows where current oyster leases are held.

Vessels use the nearby Channel to Smith Point or the Houston Ship Channel. Commercial and recreational fishing, boating, and potentially wildlife viewing does occur in the open water areas surrounding the island and the peninsula. Near the action area, but not within the construction footprint is an oyster reef, oyster lease and pipeline (Figure 8).

**#3 If habitat for species is present in the action area, provide a general description of the current state of the habitat.**

While nesting activity of colonial waterbirds has declined in recent years, birds continue to use Smith Point Island for staging, loafing, roosting, and possible nesting sites. The island supports limited colonial waterbird nesting and little species diversity due to changes in vegetation and habitat loss from erosion. Table 1 lists the species recorded nesting at Smith Point Island by the Texas Colonial Waterbird Society between 2008 and 2012. Non-colonial species that may nest on the island include the eastern willet (*Catoptrophorus semipalmatus*) and American oystercatcher (*Haematopus palliatus*). Water dependent birds may use the open bay to forage and roost. These would include loons, bay ducks, gulls, terns, and pelicans.

Table 1. Colonial waterbird species recorded nesting at Smith Point Island

Common Name	Scientific Name
Brown Pelican	<i>Pelicanus occidentalis</i>
Great Egret	<i>Ardea alba</i>
Great Blue Heron	<i>Ardea herodias</i>
Snowy Egret	<i>Egretta thula</i>
Cattle Egret	<i>Bubulcus ibis</i>
Black-crowned Night Heron	<i>Nycticorax nycticorax</i>
Roseate Spoonbill	<i>Platalea ajaja</i>
Black Skimmer	<i>Rynchops niger</i>

Non-avian terrestrial wildlife has not been observed at Smith Point Island. Texas diamondback terrapins (*Malachlemys terrapin*) may use the existing islands and surrounding waters.

Located near the island are significant accreting Eastern oyster reefs, oyster leases, and hard bottom substrate. There are areas of oyster/shell reef near the project area (Figure 8) and habitat for other aquatic species. Dominant aquatic species that could be found in the project area include fish species (sand seatrout, spotted or speckled seatrout, red drum, tonguefish, flounders, Atlantic bumper, and porgys) and benthic organisms (bivalves, gastropods and other mollusks, amphipods, annelids, and brown and white shrimp). Seagrasses are not expected and were not identified as being present using the TPWD seagrass viewer: <http://tpwd.texas.gov/gis/seagrass/>.

**# 4 Identify any management or other activities already occurring in the area.**

This island was enhanced through the construction of the Channel to Smith Point in 1950. In 2002, a federal project was initiated to improve the Channel to Smith Point by deepening the channel. Some of the dredged sediment was placed on Smith Point Island and a breakwater was installed to protect the site from erosion (Figure 4). Currently, Audubon Texas manages the island for nesting colonial waterbirds. Activities include monitoring, predator control, and educational signs to reduce disturbance. Fisherman and boaters may use the nearby open water areas for recreational or commercial purposes. Commercial lease holders for oyster fisheries maintain and manage the lease shown in Figure 8. The navigation channel may be used by vessels for transportation. USACE maintains the Houston Ship Channel for navigation. The Channel to Smith Point is not regularly maintained.

#### **#5 Detailed map of the area of potential effect for ground disturbing activities.**

The potential area of impact from the construction activities is shown in Figures 5, 7, and 8. Earthen fill material will be placed on submerged lands and shell material will be placed on top of the existing island to raise elevations. Once the earthen fill has dewatered and sediments have settled, the area between the breakwater and the existing island will be planted (about 3 acres) with shrub-scrub vegetation. In order to raise elevations of the existing island, it will be topped with material similar to the existing shell hash in structure, form, and mineral composition (calcareous). The final elevation of the improved island will be such that it will support ground nesting species of colonial waterbirds.

Specific sources of sediment/fill material have not been identified for this project. However, the potential sources of material would be from a direct dredge borrow source area, the Houston Ship Channel (Figure 7), or an unidentified upland borrow location.

#### **Section a. Waterbody (If applicable. Name the body of water, including wetlands (freshwater or estuarine), on which the project is located. If the location is in a river or estuary, please approximate the navigable distance from the project location to the marine environment.)**

Project is located within Galveston Bay, Texas. Smith Point Island is currently classified under the Cowardin classification system as Estuarine Intertidal Reef. The areas surrounding certain areas of the island contain large areas of Estuarine Subtidal Reef (a.k.a oyster/shell reef) habitat.

#### **Section b. Existing Structures (If applicable. Describe the current and historical structures found in the project area (e.g., buildings, parking lots, docks, seawalls, groynes, jetties, marina). If known, please provide the years of construction.**

There is an existing breakwater and submerged sand tube in the project area. Construction occurred between 2003 and 2004 as part of a beneficial use project to deposit sediments dredged as part of the channel maintenance near Smith Point.

#### **Section c. Seagrasses & Other Marine Vegetation**

**(If applicable. Describe seagrasses found in project area. If a benthic survey was done, provide the date it was completed and a copy of the report. Estimate the species area of coverage and density. Attach a separate map showing the location of the seagrasses in the project area.)**

There is no known submerged vegetation present at the site. There are no known seagrasses in the project area. The TPWD seagrass viewer does not show any seagrasses in the project area (<http://tpwd.texas.gov/gis/seagrass/>).

**Section d. (If applicable. Describe the mangroves found in project area. Indicate the species found (red, black, white), the species area of coverage in square footage and linear footage along project shoreline. Attach a separate map showing the location of the mangroves in the project area.)**

There are no mangroves present on the island.

#### **Section e. Corals**

**(If applicable. Describe the corals found in project area. If a benthic survey was done, provide the date it was completed and a copy of the report. Estimate the species area of coverage and density. Attach a separate map showing the location of the corals in the project area.)**

There are no corals in the project area. Appropriate habitat does not exist.

**Section f. Uplands (If applicable. Describe the current terrestrial habitat in which the project is located (e.g. pasture, forest, meadows, beach and dune habitats, etc.).**

See Existing Environmental Conditions and Characteristics and **#3 If habitat for species is present in the action area, provide a general description of the current state of the habitat** above for habitat descriptions of the island and surrounding water.

If a remote off-site borrow source is chosen as for the fill material it may be an upland area. All potential upland sites will be characterized and reviewed for environmental constraints including contaminants, habitat value, presence of protected and at-risk species, and cultural resources. Any areas with critical habitat will be avoided and the activities associated with the use of an upland borrow site would not adversely affect listed species. To the maximum extent practicable, locations with habitats of at-risk species will also be avoided.

#### **Section D.**

##### **Part 1.**

**Construction Schedule (What is the anticipated schedule for major phases of work? Include duration of in-water work.)**

Activities associated with engineering and design may take several months to accomplish with a maximum estimated timeframe of 18 months. Dredging activities may be conducted both day and night. To prevent disturbance to nearby residential communities near Smith Point, construction



activities that produce significant noise or require precision, such as moving or placing rock would be limited to daylight hours. Construction would avoid the nesting season, which is usually February 1 through August 15. Activities associated with construction, which includes “in water work” are not expected to take longer than 6 months. The timing of contracting awards and weather conditions could impact the construction schedule. However, some field activities that pose minimal disturbance may be acceptable to occur while birds are nesting. Any such activities potentially affecting ESA species or migratory birds would be coordinated with the appropriate state and federal agency biologists and with non-governmental organization (NGO) partners prior to initiation of the field work.

## **Part 2.**

### **#1 What is the purpose and need of the proposed action?**

The action falls within the scope of the programmatic purpose and need for early restoration *Deepwater Horizon* Oil Spill as described in the Programmatic and Phase III Early Restoration Plan and Early Restoration Programmatic Environmental Impact Statement because it would accelerate meaningful restoration of injured natural resources and their services resulting from the Spill. This project’s purpose is to begin to restore and protect birds injured as a result of the Spill. The project is needed to restore colonial waterbird nesting habitat in the Galveston Bay System. Restoration actions at the rookery island would increase the amount of available nesting habitat by increasing the size of the island, enhance the quality of habitat through the establishment of native vegetation, and increase the longevity of the habitat through the construction of protective features, such as breakwaters or armoring. Increasing the amount of available nesting habitat, enhancing the quality of habitat, and increasing the protection of the habitat from erosion and sea level rise would result in an increase in the numbers of nesting colonial waterbirds.

Restoration and protection of Smith Point Island is needed to protect the island from land loss associated with erosion and relative sea level rise. It will also increase the island size and elevation such that it will provide sufficient area and height to support colonial nesting birds. The island has eroded and subsided since 1995 when it was 9.5 acres in size and supported 3.7 acres of vegetated habitat. In 2013, the island was approximately 4 acres in size and supported approximately 0.6 acres of vegetation. The island is currently composed of shell and shell hash with little surface soils present. Natural vegetation has died out leaving only a few plants, primarily an exotic called *Tamarix* which can tolerate the salinity exposure. As a result, the island is experiencing changes that are not conducive to use by nesting birds.

### **#2 How do you plan to accomplish it? Describe in detail the construction equipment and methods\*\* needed; permanent vs. temporary impacts; duration of temporary impacts; dust, erosion, and sedimentation controls; restoration areas; if the project is growth-inducing or facilitates growth; whether the project is part of a larger project or plan; and what permits will need to be obtained.**

The project is currently conceptual in its design. A professional registered engineer (PE) will be hired to develop a refined design and specification package. The description of each of the construction

elements are based on experience with similar projects within Galveston Bay and should be considered typical. Uncontaminated earthen fill will be placed on submerged bay bottom adjacent to the existing island and shell material would be placed on top of the existing island to raise elevations. Island construction would use clean sediments consisting of clay, silts, and sand, which would be sculpted to prescribed slopes and elevations. Depending on specific construction techniques, temporary levees may be constructed to contain material and decant water. Once the earthen fill has dewatered and sediments have settled, a portion of the island will be planted with shrub-scrub vegetation to support nesting birds. The material placed on the island to raise elevations would be similar to the existing shell hash in structure, form, and mineral composition (calcareous) in order to provide nesting habitat for grounding nesting terns (Figure 5). In order to protect the island from adverse physical processes, the existing breakwater would be enhanced and a new breakwater would be constructed to ensure sustainability. The Smith Point Island project contains the following elements:

- Construct 6 island acres by placing clean fill over submerged land;
- Enhance 2,000 feet of existing breakwater to better protect the restored and existing island;
- Construct 250 feet of new breakwater on the northeast side of the island to protect the restored and existing island;
- Raise the elevation on 2 acres within the footprint of the existing island with shell material to build an emergent shell beach; and
- Plant 3 island acres with native shrub-scrub vegetation.

A short temporary access channel of approximately 250 feet by 50 feet may be required from the adjacent navigation channel to the existing island site (Figure 8). This channel would be no more 5 feet deep and will be backfilled when construction activities are completed.

#### Island Fill

Approximately 70,000 cubic yards of uncontaminated earthen fill material will be required to raise elevations between the breakwater and the existing island to the appropriate height (Figure 12). The volume of earthen fill material is the maximum amount of material estimated to be needed. Fill material will be sourced from beneficial use of dredged material from the Houston Ship Channel, direct dredging from a borrow source area (Figure 7), or an upland borrow site. Borrow sites determined to be suitable from an engineering perspective would be evaluated for environmental conditions to ensure that any cultural and/or sensitive resources are properly addressed. For any of these borrow sites, the material would be mixed with water, requiring a settlement period and the controlled discharge of decant water from within the placement area. The height of any temporary or permanent structure and construction methods required to contain the earthen fill would be determined by the type of material used and its estimated water content. Location of the structures would ensure containment and settlement of the fill materials, using BMPs.

All environmental reviews required for the placement of the material obtained as part of a beneficial use disposal process would be completed by the other project (e.g. a navigation improvement project). If a beneficial use site under NOAA's jurisdiction is selected, documentation of the environmental

reviews and relevant consultations will be provided to NMFS, as appropriate. If a direct dredge borrow source area is used, the borrow area would be located as near the island as feasible and would use surface bay bottom sediments. If earthen fill material is obtained from a more distant borrow area such as an upland site, the material would meet engineering requirements and the site would be reviewed and approved by resource agencies for cultural and sensitive resources including at-risk species, protected species, wetlands, contaminants, and cultural resources.

Measures to control turbidity caused by construction activities, decant water, and sediment movement would be in place to ensure sensitive habitats are protected, water quality standards are met, and sensitive resources are not affected. These measures may include appropriate water control structures (structures that allow water to exit the placement area while at the same time retain sediments within the placement area) to decant water, as well as the installation of silt fences, hay bales, filter-fabric, and/or temporary levees to control sediments and avoid negative impacts associated with the fill placement. The nearby presence of oyster reefs, other hard structure reef resources, and seagrass beds near some islands would require the use of significant control measures during project implementation.

In general, construction may require the use of barges, small watercraft, large track hoe excavators, earth moving equipment, hydraulic or mechanical dredges, and a dockside staging area. The type of dredge chosen for use will not affect sea turtles. For example, a cutterhead dredge is the hydraulic dredge that is anticipated for use. Hopper dredges will not be used. The mechanical dredge used by this project would be a dragline. Methods and tools will be approved by the professional engineer and the project team prior to implementation.

#### *Direct Dredge Borrow source area*

A direct dredge borrow source area may be used to obtain the earthen fill material required to build the island. The location of the borrow source area is shown on Figure 7. Within that area, the specific location chosen will be based on several factors including the absence of sensitive resources (e.g. oyster reef or seagrasses), geotechnical and sediment quality, nearby commercial and/or recreational activities, and lateral extent of available material (avoiding a deep borrow site). Within the direct dredge borrow source area, the PE will perform geotechnical investigations to determine potential sources of preferred and suitable sediments. Any potential sources that contain sensitive resources such as oyster reef or seagrass beds will be avoided. The resulting footprint of the borrow site within the direct dredge borrow source area will be no larger than 562,500 square feet with a depth of no more than 5 feet below grade. Although this direct dredge source area is much larger than needed, it is anticipated that approximately only 70,000 cubic yards of material would be dredged to provide the fill material needed for island construction. The shallow depth of 5 feet below grade shall minimize the potential for anoxic conditions occurring within the borrow site.

Material from source area would be mechanically excavated or hydraulically dredged. Excavators used may include a dragline or a long-arm excavator to place material on barges for transport to the island site. Cutter-head dredges or mechanical draglines pose minimal risk to pelagic aquatic organisms. (NOAA 2007). If hydraulic dredging is used, the dredge pipe will avoid disturbance to sensitive resource

areas such as oyster reefs and seagrass beds. The pipe would be routed to avoid laying on top of these resource areas and any equipment will avoid them as well. Any areas containing such resources in the construction and transport area of each project site will be visibly marked prior to start of construction. Material would be transported to the island via a hydraulic dredge pipeline or by barge if a mechanical dredge is used.

#### *Other Sources of Fill Material*

Sources of fill material other than that from the direct dredge borrow source area may be used. For an upland borrow site, the contractor will be required to provide documentation that the borrow site meets all engineering, environmental and cultural resource requirements. No upland borrow will be used that affects wetlands or listed species, and to the max extent practicable, at-risk species. Upland materials may be obtained as part of a beneficial use project. Materials associated with federally maintained navigation channels are located in USACE placement areas (PA) that can be mined as fill material. These PAs are maintained and operated as part of the GIWW federal project. Material would be mined using mechanical or hydraulic excavation techniques. Mechanically excavated material would be placed on barges and transported to the island site using ingress and egress routes depicted in Figures 6 and 7. Mechanical dredges and barges will be used to mine and transport upland material used for fill.

If dredged fill material is obtained as part of a beneficial use project, that project would be sourced from a specific reach of the Houston Ship Channel between Redfish Island and Morgan's Point. Work for this section of the Mid-Bay Reach of the Houston Ship Channel is currently under planning by the USACE Operations and Maintenance Division (Figure 7). Hydraulic dredges with a cutter-head design will be used.

#### Breakwater/Armored Levee

Breakwaters or armored levees would be installed to protect the island from erosional forces. However, they could be modified or enhanced as part of this project to act as containment for the earthen fill. Graded stone, typically limestone will be used to construct the breakwaters or armoring. The amount and size of rock used will be dependent on several factors determined in the final design. These include wave and current energy expected, as well as whether the breakwaters or armored levees would be used for containment and dewatering of sediments or only for erosion protection. Breakwaters and levees used for containment are typically higher in elevation and larger than those used solely for erosion protection. These considerations along with physical data from the site will be evaluated by a qualified coastal PE and the project team prior to selection of design. The project team will include staff from Texas Parks and Wildlife Department (TPWD), USFWS, and Audubon. The source for the material is expected to be from known and existing limestone quarries used for coastal construction projects across the western Gulf of Mexico. During construction, open tidal water areas of the site may need to be enclosed to contain material meeting standards specified for the project. Any such affected open water areas would follow Measures for Reducing Entrapment Risk to Protected Species, May 22, 2012.

[http://sero.nmfs.noaa.gov/protected\\_resources/section\\_7/guidance\\_docs/documents/entrapment\\_bmps\\_final.pdf](http://sero.nmfs.noaa.gov/protected_resources/section_7/guidance_docs/documents/entrapment_bmps_final.pdf)).

### Shell Beach Enhancement

Shell beach habitat on Smith Point Island would be enhanced to support ground nesting birds by placing material similar to the existing shell hash on top of the existing substrate. The surface of Smith Point Island is currently covered with a layer of winnowed oyster shell (fossil) approximately 1 to 2 feet thick. The shell is continually moved by wave energy which prevents the accumulation of soil or fine shell material thereby limiting the extent of vegetation establishment. Although there is currently nesting habitat for bare ground nesting birds, the elevation is currently so low that nesting birds experience nest failure with high tide events. In order to enhance the existing island, approximately 5,000 cubic yards of material similar to the existing shell hash will be deposited on the southern portion of the existing island raising the elevation approximately 1.5 feet. The final elevation of the improved island will be such that it will be suitable for shell and bare ground nesting species. The wave energy would maintain a portion of the island free from vegetation and ideal for shell and bare ground nesting birds.

Material placed onto Smith Point Island would be added in a manner that it emulates shell berms observed in nearby areas. The source of this material will be similar the shell hash present on Smith Point Island in structure, form, and mineral composition (calcareous) and be either from current shell sources, limestone, or a mixture of limestone and shell, or material similar in size shape, density, etc. This material will be inspected, clean, free of debris and invasive species and will be obtained from commercially available sources. This project component would also produce a lagoon that will support fledgling birds. Gaps will be placed within the breakwaters to ensure that both juvenile birds and aquatic organisms will have access to bay waters (Figure 12).

### Vegetation Planting

Once the earthen fill has dewatered and sediments have settled, the higher elevation portions of the restored island, about 3 acres, would be planted with native scrub-shrub vegetation to help promote desired vegetation establishment. Plants used will be species documented from similar island sites and be propagated from stock located on the upper Texas coast. Species under consideration include but are not limited to those shown in Table 2. A Vegetation Planting Plan modified from and based on the Natural Resources Conservation Service (NRCS) Publication NRCS-TX-612 would be developed prior to implementation (NRCS 2013, attached). This plan will provide specifications for the species of native vegetation to be used; acceptable source stock; planting densities and locations on the island for planting; survival targets and adaptive management strategies. The plan will be used by the contractor and the project team. Expected plants survival is approximately 60% at the end of the 5-year monitoring period. Protective measures may include trunk collars or wire exclusion cages to protect saplings from herbivory or trampling during the first few years after planting. Time of year as well as substrate salinity will determine the timing for planting. It is anticipated that this will take place approximately one year after construction, depending on environmental conditions.

Table 2. Examples of native scrub shrub species proposed for transplanting.

Common Name	Scientific Name
Colima	<i>Zanthoxylum fagara</i>
Woollybucket Bumelia	<i>Sideroxylon lanuginosum</i>
Prickly Pear Cactus	<i>Opuntia dillenii</i>
Desert Olive	<i>Forestiera augustifolia</i>
Huisache	<i>Acacia farnesiana</i>
Jerusalem Thorn	<i>Parkinsonia aculeata</i>

Construction Schedule

Activities associated with engineering and design may take several months to accomplish with a maximum estimated timeframe of 18 months. Dredging activities will be conducted both day and night. To prevent disturbance to nearby residential communities near Smith Point, construction activities that produce significant noise or require precision, such as moving or placing rock would be limited to daylight hours. Construction would avoid the nesting season, which is February 1 through August 15. Activities associated with construction, which includes “in water work” are not expected to take longer than 6 months. The timing of contracting awards and weather conditions could impact the construction schedule. However, some field activities that pose minimal disturbance may be acceptable to occur while birds are nesting. Any such activities potentially affecting migratory birds would be coordinated with the appropriate state and federal agency biologists and with non-governmental organization (NGO) partners prior to initiation of the field work.

Describe permanent and temporary impacts, duration of temporary impacts, dust, erosion, and sedimentation controls

Construction activities will cause temporary impacts to wildlife due to the presence of people and use of heavy equipment on the island and in the borrow area. These impacts would last for the duration of construction, which is estimated to be less than 6 months. Permanent impacts will include establishment of a 6 acre island in the area that currently exists between the current island and the previously constructed breakwater. The existing island will be impacted by the placement of shell-like hash material on two of its acres. A temporary access channel will be excavated so that equipment can access the island and will be backfilled after construction is completed, approximately 6 months.

If the direct dredge borrow source area is used, a borrow site approximately 12 acres (562,500 square feet) in size and no deeper than 5 feet below grade would be excavated. This site would slowly accrete sediments delivered from the river inflow and movement from surrounding bay bottoms. Some

turbidity would take place but be minimized through the use of silt fences and other water quality best management practices. Impacts associated with beneficial use of dredged material would include some turbidity; however, it would be minimized through the use of appropriate BMPs. These measures include appropriate water control structures to decant water such as silt fences, hay bales, filter-fabric, and temporary levees to control sediments and avoid negative impacts associated with the fill placement. The nearby presence of oyster reefs requires the use of significant control measures during project implementation.

There will be no significant impacts due to dust because sediments deposited will be mixed with water, keeping airborne particles to a minimum. In addition, the island is uninhabited and will not be affecting any residents. Impacts due to dust and erosion would also be minimized by the best management practices that were discussed above. No hazardous waste would be created during construction. All hazardous substances handled during construction would be contained and appropriate barriers would be in place to ensure the protection of adjacent water resources from potential spills and leaks. In the event of a discharge of oil or release of hazardous substances, the release would be reported to the National Response Center (800-424-8802) and Texas Emergency Oil Spill and Hazardous Substance Reporting line (800-832-8224) as required. BMPs in accordance with Occupational Safety and Health Administration and state and local requirements would be incorporated into construction activities on site to ensure the proper handling, storage, transport and disposal of all hazardous materials.

Permanent impacts result from an alteration in habitat type which will benefit nesting birds in the long term. Beyond the vegetated plantings, natural plant colonization will occur and will provide, in part, grassy substrate which could be used by the colonial nesting birds. The breakwaters, armored levees, other levee and land height would protect the site from erosion.

Is the project part of a larger project or plan?

This project is one of four bird rookery restoration projects to occur in Texas as part of Phase IV Early Restoration funding from the BP oil spill (Figure 1). Restoration and protection of the Galveston Bay rookery islands, including Smith Point Island, supports the needs or goals of multiple conservation plans. Plans include but are not limited to the following national, state and regional planning documents:

- The Galveston Bay Plan: The Comprehensive Conservation and Management Plan for the Galveston Bay Ecosystem (Galveston Bay Estuary Program [GBEP] 1994);
- Galveston Bay Habitat Conservation Blueprint: A Plan to Restore the Habitats and Heritage of Galveston Bay Habitat (Galveston Bay Foundation 1998);
- Waterbird Conservation for the Americas: The North American Waterbird Conservation Plan, Version 1 (Kushlan et. al. 2002);
- Southeast United States Regional Waterbird Conservation Plan (U.S. Fish and Wildlife Service [USFWS] and North Carolina Audubon Society 2006);
- Strategic Plan: The Coastal Program Stewardship of Fish and Wildlife Through Voluntary Conservation Regional Step-Down Plan Region 2 (Texas) Part 2 of 3 FY 2006-2010 (USFWS 2006);

- Charting the Course to 2015: Galveston Bay Strategic Action Plan (GBEP 2009);
- Gulf Coast Joint Venture Conservation Planning for Reddish Egret (Vermillion and Wilson 2009);
- Texas Conservation Action Plan 2012 – 2016: Gulf Coast Prairies and Marshes Handbook (Texas Parks and Wildlife Department [TPWD] 2012);
- Texas Mid-Coast Initiative Area Fact Sheet (Gulf Coast Joint Venture 2012);
- Reddish Egret Conservation Action Plan (Wilson et. al. 2014); and
- Draft Texas Colonial Waterbird Rookery Island Conservation Plan (Audubon Texas 2014).

The information provided in each of the planning documents listed above may be for a specific species or may target a group or guild of waterbirds. Actions or recommendations in each may be directly related to restoration of a specific island; typical nesting islands, or emphasizes the need of a species that will benefit from the Galveston Bay rookery islands.

#### What permits will need to be obtained?

USACE Section 10 and Section 404 (combined) permit will be needed for this project. The lands are managed by Chambers-Liberty Counties Navigation District and they have issued a lease to Audubon Texas for management of the island. Any additional lease(s) for managing the submerged bay bottom and the construction activities would be obtained prior to implementing the proposed restoration.

**#3 Attach a separate map showing project footprint, avoidance areas, construction accesses, staging/laydown areas. \*\*If construction involves overwater structures, pilings and sheetpiles, boat slips, boat ramps, shoreline armoring, dredging, blasting, or artificial reefs, list the method here, but complete the next section(s) in detail.**

Smith Point Island lies approximately 1.25 miles west of Smith Point peninsula and is approximately 1.5 miles from the nearest boat dock on the peninsula (Figure 3). The project footprint and affected area is shown on Figures 7 and 12. The area that may be directly or indirectly affected includes the island, direct dredge borrow source area, navigation corridors in the Galveston Bay System, Houston Ship Channel between Redfish and Morgan's Point.

The nearest dock to the project site is located on Smith Point peninsula and may be used to load material for transport to the project area. If barges are used, they will likely enter from the intercostal waterway, travel through the Houston Ship Channel and continue traveling to the project site via a navigation channel (Figures 6 and 7). The Texas General Land Office has identified places to access to coastal waterways at [http://www.glo.texas.gov/texas-beach-access/beach\\_bay.html](http://www.glo.texas.gov/texas-beach-access/beach_bay.html). Information specific to Galveston County is located at <http://www.glo.texas.gov/texas-beach-access/pdf/beach-bay/Galveston.pdf>. There will be no impacts to existing submerged oyster reef, pipelines or the surrounding waterways (Figure 8).

**Part 3: Specific In-Water Construction Methods (Provide a detailed account of construction methods. It is important to include step-by-step descriptions of how**



**demolition or removal of structures is conducted and if any debris will be moved and how. Describe how construction will be implemented, what type and size of materials will be used and if machines will be used, manual labor, or both. Indicated if work will be done from upland, barge, or both.)**

See above.

**a. Overwater Structures**

**#1 Is the proposed use of this structure for a docking facility or an observation platform? No**

**#2 If no, is this a fishing pier? Public or Private? How many people are expected to fish per day? How do you plan to address hook and line captures? This is not a fishing pier.**

**#3 Use of "Dock Construction Guidelines"?**

<http://sero.nmfs.noaa.gov/pr/endangered%20species/Section%207/DockGuidelines.pdf>

This is not applicable. No dock is being constructed.

**#4 Type of decking: Grated – 43% open space; Wooden planks or composite planks – proposed spacing? There is no decking**

**#5 Height above Mean High Water (MHW) elevation?**

The target elevation for the restored island would place the crown at least 4 feet above mean tide level post-settlement sloping to existing grades. These elevations could be adjusted once the designs are finalized. Land heights will be appropriate for ground nesting birds.

**#6 Directional orientation of main axis of dock?**

Not applicable.

**#7 Overwater area (sqft)?**

Not applicable.

**# 8 Use of "Sea Turtle and Smalltooth Sawfish Construction Conditions, March 2006"**

<http://sero.nmfs.noaa.gov/pr/endangered%20species/Sea%20Turtle%20and%20Smalltooth%20Sawfish%20Construction%20Conditions%203-23-06.pdf>

These construction guidelines will be followed for the in-water work.

**b. Pilings & Sheetpiles (What type of material is the piling or sheetpiles? What size and how many will be used? Method used to install: impact hammer, vibratory hammer, jetting, etc.?) Not applicable.**

**c. Boat Slips (Describe the number and size of slips and if the number of new slips changes from what is currently available at the project. Indicate how many are wet slips and how many are dry slips. Estimate the shadow effect of the boats - the area (sqft) beneath the boats that will be shaded.) Boat slips are not part of this project.**

- d. Boat Ramp (Describe the number and size of boat ramps, the number of vessels that can be moored at the site (e.g., staging area) and if this is a public or private ramp. Indicate the boat trailer parking lot capacity, and if this number changes from what is currently available at the project.)** Boat ramps are not part of this project.
  
- e. Shoreline Armoring (This includes all manner of shoreline armoring (e.g., riprap, seawalls, jetties, groins, breakwaters, etc.). Provide specific information on material and construction methodology used to install the shoreline armoring materials. Include linear footage and square footage. Attach a separate map showing the location of the shoreline armoring in the project area.)**

Figure 5 shows the location of shoreline armoring. See above for a description of shoreline armoring and a typical design can be considered in Figure 10.

Measures for Reducing Entrapment Risk to Protected Species, dated May 22, 2012 will be followed ([http://sero.nmfs.noaa.gov/protected\\_resources/section\\_7/guidance\\_docs/documents/entrapment\\_bmps\\_final.pdf](http://sero.nmfs.noaa.gov/protected_resources/section_7/guidance_docs/documents/entrapment_bmps_final.pdf)).

- f. Dredging or digging (Provide details about dredge type (hopper, cutterhead, clamshell, etc.), maximum depth of dredging, area (ft<sup>2</sup>) to be dredged, volume of material (yd<sup>3</sup>) to be produced, grain size of material, sediment testing for contamination, spoil disposition plans, and hydrodynamic description (average current speed/direction)). See Section D, Part 2.**

Construction activities at the site would include the placement of approximately 70,000 cubic yards of earthen fill to create an island. A temporary access channel would be constructed to access the site from the nearby navigation channel. It would be approximately 250 feet by 50 feet and no more than 5 feet deep. This material would be sidecast and backfilled once construction is completed. Once the temporary access channel is in place, temporary levees would be constructed to contain earthen material. The existing breakwater would be enhanced and increased in size. New components of the breakwater would be added to ensure material is contained. Any construction activities that would involve potential entrapment would follow the guidelines indicated in 8.e. (above). Appropriate measures to reduce impacts from decant water will be used (see below). Material placed to create the island may require a drying period prior to shaping and sculpting with earth moving equipment. Shell-like hash material would be placed on two acres of the existing island.

A direct dredge borrow source area may be used to obtain the source material. A borrow source area has been identified and is shown in Figure 7 bounded by 29.5598 E, -94.8600 W; 29.5598 E, -94.8500 W; 29.5800 E, -94.8600 W; and 29.5800 E, -94.8500 W. A specific borrow site chosen within this area would be approximately 562, 500 square feet in area. It would be no deeper than 5 feet below grade. The most desirable material used as fill for the island would have a relatively high sand content. However, material comprised of silts and clays would also be acceptable. Once identified, the specific site would be surveyed for important habitats such as oyster reef and

seagrasses and for cultural resources. Any important sensitive resources would be avoided. Over time, the excavated area would accrete sediments delivered from the river inflow and movement from surrounding bay bottoms. Some temporary turbidity would take place but would be minimized by the use of silt fences and other water quality BMPs. Impacts associated with beneficial use of dredged material would include some turbidity. However, the impacts would be minimized through the use of appropriate BMPs. These measures include appropriate water control structures to decant water such as silt fences, hay bales, filter-fabric, and temporary levees to control sediments and avoid negative impacts associated with the fill placement.

There are no known contaminants associated with the direct dredge borrow source area. Screening for potential chemical contaminants will be conducted on a case-by-case basis.

For sediments from federally-maintained navigation channels or associated dredged material placement areas, previously collected contaminant analysis and bio-assay data will be obtained from the U.S. Army Corps of Engineers Galveston District (USACE) - Operations Branch records.

For bay bottom borrow sites, local and regional knowledge of historical industrial activities as well as regulatory documentation on past and existing facilities in the vicinity of potential sediment borrow sources will be used to determine the likelihood and type of contaminants that might be expected to be encountered during construction. Based upon this information, USACE and state and federal resource agency personnel will be consulted to determine the amount of sampling and the type of chemical analyses that need to be conducted.

Equipment and materials for the construction activities would be transported via roads and via marine waterways. The nearby boat dock at Smith Point peninsula, which is just over three miles away, may be used to load and transport materials. Large equipment and materials moved by barges will use the established interconnected waterways. This may include the Gulf Intracoastal Waterway, the Houston Ship Channel and other navigation channels (Figure 7). The island restoration area and the location where fill material will be obtained will have a staging area identified. The locations for staging sites will be placed to avoid sensitive resource areas such as oyster reefs and seagrass beds. Equipment may be staged at these locations for a period of time up to several weeks and or months. The staging areas will be adjacent to the location where sediment sources are obtained (Houston Ship Channel, the direct dredge borrow source area, or other upland location).

There will be no significant impacts due to dust because sediments deposited will be mixed with water, keeping airborne particles to a minimum. In addition, the island is uninhabited and will not be affecting any residents. Impacts due to dust and erosion would also be minimized by the best management practices that were discussed above. No hazardous waste would be created during construction. All hazardous substances handled during construction would be contained and appropriate barriers would be in place to ensure the protection of adjacent water resources from potential spills and leaks. In the event of a discharge of oil or release of hazardous substances, the

release would be reported to the National Response Center (800-424-8802) and Texas Emergency Oil Spill and Hazardous Substance Reporting line (800-832-8224) as required. BMPs in accordance with Occupational Safety and Health Administration and state and local requirements would be incorporated into construction activities on site to ensure the proper handling, storage, transport and disposal of all hazardous materials.

Permanent impacts result from an alteration in habitat type which will benefit nesting birds in the long term. Beyond the vegetated plantings, natural colonization will occur and will provide, in part, grassy substrate which could be used by the colonial nesting birds. The breakwaters, armored levees, other levee and land height may decrease wave energy. Surveys delineating the presence, type and extent of reef and bottom substrates will be completed prior to finalizing full project elements and design. Oyster reefs will be avoided during construction.

The construction activities including transportation, mining and transportation of fill material, and staging areas associated with the restoration of Smith Point Island will not adversely affect any sensitive resources. Sediment and turbidity controls will be in place so that the surrounding sensitive habitats (oyster reefs and/or seagrass beds) are not significantly affected. Although there will be noise and equipment activity associated with movement of construction materials, mobile organisms will avoid the area which will eliminate the chance for significant impacts to these resources. Some sessile organisms may be affected; however, best management practices will be employed to prevent any impacts to fish and wildlife and/or sensitive resources such as oyster reef beds. Refer to descriptions below for further details.

Several different types of barges and vessels may be used in construction operations. A hydraulic cutter-head dredge vessel would be used in conjunction with this method for moving material from the borrow site to the island construction site. Smaller water craft may also be used to transport personnel and small quantities of material between larger barges and vessels. In general, all types of barges will be operated to avoid depths inconsistent with their draft. Barges bearing significant amounts of material from source sites, e.g. limestone rock, will be staged near but outside of navigation channels. When appropriate, material will be transferred to barges of shallower draft (placement barges) in order to reach the site. Barges containing work equipment such as excavators and/or draglines would also be used. Propeller wash of the bay bottom and substrate will be avoided. Construction activities may require excavation of a temporary access channel from the barge draft limit to the island. The access channel is expected to be no deeper than 5 feet, have a maximum width of 50 feet, and a maximum length of 250 feet. Once all the fill materials and protective structures have been constructed, the access channels will be backfilled, thus preventing any long term impacts to the bay bottom from the access channel construction.

- g. Blasting (Projects that use blasting might not qualify as “minor projects,” and a Biological Assessment (BA) may need to be prepared for the project. Arrange a technical consultation meeting with NMFS Protected Resources Division to determine if a BA is necessary. Please include explosive weights and blasting plan.).** This project does not involve blasting activities.

- h. Artificial Reefs (Provide a detailed account of the artificial reef site selection and reef establishment decisions (i.e., management and siting considerations, stakeholder considerations, environmental considerations), deployment schedule, materials used, deployment methods, as well as final depth profile and overhead clearance for vessel traffic. For additional information and detailed guidance on artificial reefs, please refer to the artificial reef program websites for the particular state the project will occur in. Artificial reef creation is not part of this project.**

## **Section E.**

### **#1 List all species, critical habitat, proposed species and proposed critical habitat that may be found in the action area.**

There is no critical habitat within the action area.

Attwater's Greater prairie chicken, *Tympanuchus cupido attwaterii* – Endangered

Piping plover, *Charadrius melodus* – Threatened

Red knot, *Caladris canutus rufa* - Threatened

Sprague's Pipit, *Anthus spragueii* – Candidate Species

West Indian Manatee, *Trichechus manatus* – Endangered

Green Sea Turtle, *Chelonia mydas* – Endangered\*

Hawksbill Sea Turtle, *Eretmochelys imbricata* — Endangered\*

Kemp's Ridley Sea Turtle, *Lepidochelys kempii* — Endangered\*

Leatherback Sea Turtle, *Demochelys coriacea* – –Endangered\*

Loggerhead Sea Turtle, *Caretta caretta* – – Threatened\*

Smalltooth Sawfish, *Pristis pectinata* – Endangered

\* - This biological assessment is limited to potential impacts to these species within the bay and outside of their nesting habitat (beaches) since there is no nesting habitat within the action area. This project will have no impacts or influence to Gulf beach front.

### **#2 Attach a separate map identifying species/critical habitat locations within the action area.**

The attached maps are indicative of species locations as displayed by USFWS. There is no critical habitat for any species within the project area. Distribution maps were downloaded from the USFWS Ecological Services webpage for Region 2 on 27 February 2015

([http://www.fws.gov/southwest/es/ES\\_ListSpecies.cfm](http://www.fws.gov/southwest/es/ES_ListSpecies.cfm)).

## Section F

### Part 1:

**Explain the potential beneficial and adverse effects to each species listed above (Describe what, when, and how the species will be impacted and the likely response to the impact. Be sure to include direct, indirect, interdependent, interrelated, connected actions, and cumulative impacts. Where possible, quantify effects. If species are present (or potentially present) and will not be adversely affected describe your rationale. If species are unlikely to be present in the general area or action area, explain why. This justification provides documentation for your administrative record, avoids the need for additional correspondence regarding the species, and helps expedite review.)**

#### Attwater's Greater prairie-chicken:

There will be no effects to this species. The species occupies large expanses of coastal prairie which does not exist on Smith Point Island and the species has been extirpated from Galveston County.

#### Piping Plover:

The project may affect but is not likely to adversely affect this species. The piping plover is a winter resident on the Texas coast and occurs in Galveston County. However, there are no documented records of piping plovers on Smith Point Island. Piping plovers are not expected to occur in the construction area because typical habitats, beach and bayside tidal flat habitats, for the species do not exist. Construction activities will occur when the species is present along the Texas coastline. Individual piping plovers could rest at Smith Point Island. Piping plovers, if present and disturbed by the noise, have access to nearby habitat that is within their normal flying distances for daily foraging movement. Upland excavation activities will not occur in habitat used by this species.

#### Red Knot:

The project may affect but is not likely to adversely affect this species. The red knot is primarily migratory in Galveston County. Migration of the red knot has been observed during the Smith Point Hawk Watch, approximately 1.5 miles from Smith Point Island. However, red knots are not expected to occur in the construction area because typical habitats, beach and bayside tidal flat habitats, for the species do not exist. Construction activities will occur when the species is present along the Texas coastline. Individual red knots could rest at Smith Point Island. Red knots, if present and disturbed by the noise, have access to nearby habitat that is within their normal flying distances for daily foraging movement. Upland excavation activities will not occur in habitat used by this species.

#### Sprague's Pipit:

This project may affect, but is not likely to adversely affect this species. This species has not been observed on Smith Point Island or the action area and is not expected to occur in the project area because appropriate habitat does not exist. Construction activities associated with an upland borrow

site may occur in the winter when the species could be present. Sprague's pipit, if present and disturbed by the upland borrow site activities would have access to nearby habitat that is within their normal flying distances for daily foraging movement. No additional actions are necessary

West Indian Manatee:

The project may affect, but is not likely to adversely affect this species. This species rarely enters Texas waters and is not likely to occur in the action area. If present, the conservation measures below in Section G will be followed.

Green Sea Turtle:

This project may affect but is not likely to adversely affect this species. No sea turtle nesting activities are expected to occur here since there is no beach habitat. Green Sea Turtles do occur in Galveston Bay and may be in the water during construction activities including excavation of island building material on submerged lands near the island. However, methods used to remove material from the borrow site will be with a mechanical dredge (dragline) and barge or a hydraulic dredge (cutter-head) and pipeline dragline, both of which would have minimal impacts to pelagic species.

Impacts to bay bottom would have minimal impacts to foraging habitat for this species because this project will avoid and/or minimize impacts to seagrass beds and oyster reef habitats. Green sea turtles are specialist feeders that target sponges and seagrass or macroalgae. Substrate at the aquatic borrow areas largely consists of unvegetated sandy bottom.

Hawksbill Sea Turtle:

This project may affect but is not likely to adversely affect this species. No sea turtle nesting activities are expected to occur here since there is no beach habitat. This species is rarely seen in Galveston Bay. These sea turtles may be in the water during construction activities including excavation of island building material on submerged lands near the island. However, methods used to remove material from the borrow site will be with mechanical dredge (dragline) and barge or a hydraulic dredge (cutter-head) and pipeline, both of which would have minimal impacts to pelagic species.

Impacts to bay bottom would have minimal impacts to foraging habitat for this species because this project will avoid and/or minimize impacts to seagrass beds and oyster reef habitats. Hawksbill sea turtles are specialist feeders that target sponges and seagrass or macroalgae. Substrate at the dredging and disposal sites largely consists of unvegetated sandy bottom.

Kemp's Ridley Sea Turtle:

This project may affect but is not likely to adversely affect this species. No sea turtle nesting activities are expected to occur here since there is no beach habitat. Kemp's Ridley sea turtles do occur in Galveston Bay and may be in the water during construction activities including excavation of island building material on submerged lands near the island. However, methods used to remove material from

the borrow site will be with a mechanical dredge (dragline) and barge or a hydraulic dredge (cutter-head) and pipeline, both of which would have minimal impacts to pelagic species.

The effects due to loss of foraging habitat on Kemp's ridley sea turtles are insignificant. This species is a generalist carnivore, typically preying on benthic mollusks and crustaceans in the nearshore environment. Kemp's ridley can be found foraging in shallow sandy habitat. However, any impacts to foraging habitat for Kemp's ridleys will be temporary and would only affect a small area relative to the foraging habitat available in the nearshore marine environment off Texas.

Leatherback Sea Turtle:

This project may affect but is not likely to adversely affect this species. No sea turtle nesting activities are expected to occur here since there is no beach habitat. This species is rarely seen in Galveston Bay. These sea turtles may be in the water during construction activities including excavation of island building material on submerged lands near the island. However, methods used to remove material from the borrow site will be with a mechanical dredge (dragline) and barge or a hydraulic dredge (cutter-head) and pipeline, both of which would have minimal impacts to pelagic species. Impacts to bay bottom would have minimal impacts to foraging habitat for this species since it is a pelagic feeder.

Loggerhead Sea Turtle:

This project may affect but is not likely to adversely affect this species. No sea turtle nesting activities are expected to occur here since there is no beach habitat. This species is rarely seen in Galveston Bay. These sea turtles may be in the water during construction activities including excavation of island building material on submerged lands near the island. However, methods used to remove material from the borrow site will be with a mechanical dredge (dragline) and barge or a hydraulic dredge (cutter-head) and pipeline, both of which would have minimal impacts to pelagic species.

The effects due to loss of foraging habitat on loggerhead sea turtles are insignificant. This species is a generalist carnivore, typically preying on benthic mollusks and crustaceans in the nearshore environment. Loggerheads can be found foraging in shallow sandy habitat. However, any impacts to foraging habitat for loggerheads will be temporary and would only affect a small area relative to the foraging habitat available in the nearshore marine environment off Texas.

Smalltooth Sawfish:

There will be no impacts to this species from this project. This species is considered extirpated in Texas.

**Part 2:**

**Explain the potential beneficial and adverse effects to critical habitat listed above (Describe what, when, and how the critical habitat will be impacted and the likely response to the impact. Be sure to include direct, indirect, interdependent, interrelated, connected actions, and cumulative impacts.**



**Where possible, quantify effects (e.g. acres of habitat, miles of habitat). Describe your rationale if designated or proposed critical habitats are present and will not be adversely affected.**

There is no critical habitat in the project area.

## **Section G**

### **Part 1**

**Explain the actions to reduce adverse effects to each species listed above (For each species for which impacts were identified, describe any conservation measures (e.g. BMPs) that will be implemented to avoid or minimize the impacts. Conservation measures are designed to avoid or minimize effects to listed species and critical habitats or further the recovery of the species under review. Conservation measures are considered part of the proposed action and their implementation is required. Any changes to, modifications of, or failure to implement these conservation measures may result in a need to reinitiate this consultation.)**

#### Attwater's Greater prairie-chicken:

There will be no effects to this species. No additional actions are necessary.

#### Piping Plover:

The project may affect but is not likely to adversely affect this species. The piping plover is a winter resident on the Texas coast and occurs in Galveston County. However, there are no documented records of piping plovers on Smith Point Island. Piping plovers are not expected to occur in the construction area because typical habitats, beach and bayside tidal flat habitats, for the species do not exist. Construction activities will occur when the species is present along the Texas coastline. Individual piping plovers could rest at Smith Point Island. Piping plovers, if present and disturbed by the noise, have access to nearby habitat that is within their normal flying distances for daily foraging movement. Upland excavation activities will not occur in habitat used by this species.

#### Red Knot:

The project may affect but is not likely to adversely affect this species. The red knot is primarily migratory in Galveston County. Migration of the red knot has been observed during the Smith Point Hawk Watch, approximately 1.5 miles from Smith Point Island. However, red knots are not expected to occur in the construction area because typical habitats, beach and bayside tidal flat habitats, for the species do not exist. Construction activities will occur when the species is present along the Texas coastline. Individual red knots could rest at Smith Point Island. Red knots, if present and disturbed by the noise, have access to nearby habitat that is within their normal flying distances for daily foraging movement. Upland excavation activities will not occur in habitat used by this species.

Sprague's Pipit:

The project may affect but is not likely to adversely affect this species. Construction activities associated with an upland borrow site may occur in the winter when the species could be present. Sprague's pipit, if present and disturbed by the upland borrow site activities would have access to nearby habitat that is within their normal flying distances for daily foraging movement. No additional actions are necessary.

West Indian Manatee:

The project may affect but is not likely to adversely affect this species. All construction personnel will be notified of the potential presence of West Indian Manatee in the water and reminded of the criminal and civil penalties associated with harassing, injuring, or killing West Indian Manatees. All workers will be educated that there could be West Indian manatees in the water and will be advised to look for manatees and, if observed, wait until manatees leave the area to put the equipment in the water. Care will be taken when using equipment in the water to ensure that no harm is caused to any West Indian Manatee that may be nearby. Should a West Indian Manatee come within 50 foot of the project area during construction activities, work would immediately cease until the West Indian Manatee has moved away from the project area on its own. Construction noise will be kept to the minimum feasible.

Green Sea Turtle:

This project may affect but is not likely to adversely affect this species. Sea turtle and smalltooth sawfish construction conditions and measures for reducing entrapment risk to protected species will be followed for all aspects of this project

([http://sero.nmfs.noaa.gov/protected\\_resources/section\\_7/guidance\\_docs/documents/sea\\_turtle\\_and\\_smalltooth\\_sawfish\\_construction\\_conditions\\_3-23-06.pdf](http://sero.nmfs.noaa.gov/protected_resources/section_7/guidance_docs/documents/sea_turtle_and_smalltooth_sawfish_construction_conditions_3-23-06.pdf);  
[http://sero.nmfs.noaa.gov/protected\\_resources/section\\_7/guidance\\_docs/documents/entrapment\\_bmps\\_final.pdf](http://sero.nmfs.noaa.gov/protected_resources/section_7/guidance_docs/documents/entrapment_bmps_final.pdf)).

Methods used to remove material from the borrow site will be with a hydraulic dredge (cutter-head design) or a mechanical dredge (dragline) both of which would have minimal impacts to pelagic species. Sea turtles may be affected by dredging activities if they were to be struck by the transit and anchoring of the dredge at the project site or by the placement of fill material below mean high water. However, these effects are discountable because sea turtles are highly mobile and can avoid the area during dredging and sand placement activities and through the implementation of NMFS' Sea Turtle and Smalltooth Sawfish Construction Conditions. Application of fill material is a slow process allowing time for sea turtles to leave the area.

NMFS has previously determined that non-hopper-type dredging activities are unlikely to adversely affect sea turtles. Hydraulic dredges are not known to take sea turtles whereas hopper dredges are known to take sea turtles. Therefore hopper dredges will not be used in this project.

Hawksbill Sea Turtle:

The project may affect but is not likely to adversely affect this species. Sea turtle and smalltooth sawfish construction conditions and measures for reducing entrapment risk to protected species will be followed for all aspects of this project

[http://sero.nmfs.noaa.gov/protected\\_resources/section\\_7/guidance\\_docs/documents/sea\\_turtle\\_and\\_smalltooth\\_sawfish\\_construction\\_conditions\\_3-23-06.pdf](http://sero.nmfs.noaa.gov/protected_resources/section_7/guidance_docs/documents/sea_turtle_and_smalltooth_sawfish_construction_conditions_3-23-06.pdf);  
[http://sero.nmfs.noaa.gov/protected\\_resources/section\\_7/guidance\\_docs/documents/entrapment\\_bmps\\_final.pdf](http://sero.nmfs.noaa.gov/protected_resources/section_7/guidance_docs/documents/entrapment_bmps_final.pdf)).

Methods used to remove material from the borrow site will be with a hydraulic dredge (cutter-head design) or a mechanical dredge (dragline) both of which would have minimal impacts to pelagic species. Sea turtles may be affected by dredging activities if they were to be struck by the transit and anchoring of the dredge at the project site or by the placement of dredged material below mean high water. However, these effects are discountable because sea turtles are highly mobile and can avoid the area during dredging and sand placement activities and through the implementation of NMFS' Sea Turtle and Smalltooth Sawfish Construction Conditions. Application of fill material is a slow process allowing time for sea turtles to leave the area.

NMFS has previously determined that non-hopper-type dredging activities are unlikely to adversely affect sea turtles. Hydraulic dredges are not known to take sea turtles whereas hopper dredges are known to take sea turtles. Therefore hopper dredges will not be used in this project.

#### Leatherback Sea Turtle:

The project may affect but is unlikely to adversely affect this species. Sea turtle and smalltooth sawfish construction conditions and measures for reducing entrapment risk to protected species will be followed for all aspects of this project

[http://sero.nmfs.noaa.gov/protected\\_resources/section\\_7/guidance\\_docs/documents/sea\\_turtle\\_and\\_smalltooth\\_sawfish\\_construction\\_conditions\\_3-23-06.pdf](http://sero.nmfs.noaa.gov/protected_resources/section_7/guidance_docs/documents/sea_turtle_and_smalltooth_sawfish_construction_conditions_3-23-06.pdf);  
[http://sero.nmfs.noaa.gov/protected\\_resources/section\\_7/guidance\\_docs/documents/entrapment\\_bmps\\_final.pdf](http://sero.nmfs.noaa.gov/protected_resources/section_7/guidance_docs/documents/entrapment_bmps_final.pdf)).

Methods used to remove material from the borrow site will be with a hydraulic dredge (cutter-head design) or a mechanical dredge (dragline) both of which would have minimal impacts to pelagic species. Sea turtles may be affected by dredging activities if they were to be struck by the transit and anchoring of the dredge at the project site or by the placement of dredged material below mean high water. However, these effects are discountable because sea turtles are highly mobile and can avoid the area during dredging and sand placement activities and through the implementation of NMFS' Sea Turtle and Smalltooth Sawfish Construction Conditions. Application of fill material is a slow process allowing time for sea turtles to leave the area.

NMFS has previously determined that non-hopper-type dredging activities are unlikely to adversely affect sea turtles. Hydraulic dredges are not known to take sea turtles whereas hopper dredges are known to take sea turtles. Therefore hopper dredges will not be used in this project.

Kemp's Ridley Sea Turtle

The project may affect but is not likely to adversely affect this species. Sea turtle and smalltooth sawfish construction conditions and measures for reducing entrapment risk to protected species will be followed for all aspects of this project

([http://sero.nmfs.noaa.gov/protected\\_resources/section\\_7/guidance\\_docs/documents/sea\\_turtle\\_and\\_smalltooth\\_sawfish\\_construction\\_conditions\\_3-23-06.pdf](http://sero.nmfs.noaa.gov/protected_resources/section_7/guidance_docs/documents/sea_turtle_and_smalltooth_sawfish_construction_conditions_3-23-06.pdf);

[http://sero.nmfs.noaa.gov/protected\\_resources/section\\_7/guidance\\_docs/documents/entrapment\\_bmps\\_final.pdf](http://sero.nmfs.noaa.gov/protected_resources/section_7/guidance_docs/documents/entrapment_bmps_final.pdf)).

Methods used to remove material from the borrow site will be with a hydraulic dredge (cutter-head design) or a mechanical dredge (dragline) both of which would have minimal impacts to pelagic species. Sea turtles may be affected by dredging activities if they were to be struck by the transit and anchoring of the dredge at the project site or by the placement of dredged material below mean high water. However, these effects are discountable because sea turtles are highly mobile and can avoid the area during dredging and sand placement activities and through the implementation of NMFS' Sea Turtle and Smalltooth Sawfish Construction Conditions. Application of fill material is a slow process allowing time for sea turtles to leave the area.

NMFS has previously determined that non-hopper-type dredging activities are unlikely to adversely affect sea turtles. Hydraulic dredges are not known to take sea turtles whereas hopper dredges are known to take sea turtles. Therefore hopper dredges will not be used in this project.

Loggerhead Sea Turtle:

The project may affect but is not likely to adversely affect this species. Sea turtle and smalltooth sawfish construction conditions and measures for reducing entrapment risk to protected species will be followed for all aspects of this project

([http://sero.nmfs.noaa.gov/protected\\_resources/section\\_7/guidance\\_docs/documents/sea\\_turtle\\_and\\_smalltooth\\_sawfish\\_construction\\_conditions\\_3-23-06.pdf](http://sero.nmfs.noaa.gov/protected_resources/section_7/guidance_docs/documents/sea_turtle_and_smalltooth_sawfish_construction_conditions_3-23-06.pdf);

[http://sero.nmfs.noaa.gov/protected\\_resources/section\\_7/guidance\\_docs/documents/entrapment\\_bmps\\_final.pdf](http://sero.nmfs.noaa.gov/protected_resources/section_7/guidance_docs/documents/entrapment_bmps_final.pdf)).

Methods used to remove material from the borrow site will be with a hydraulic dredge (cutter-head design) or a mechanical dredge (dragline) both of which would have minimal impacts to pelagic species. Sea turtles may be affected by dredging activities if they were to be struck by the transit and anchoring of the dredge at the project site or by the placement of dredged material below mean high water. However, these effects are discountable because sea turtles are highly mobile and can avoid the area during dredging and sand placement activities and through the implementation of NMFS' Sea Turtle and Smalltooth Sawfish Construction Conditions. Application of fill material is a slow process allowing time for sea turtles to leave the area.

NMFS has previously determined that non-hopper-type dredging activities are unlikely to adversely affect sea turtles. Hydraulic dredges are not known to take sea turtles whereas hopper dredges are known to take sea turtles. Therefore hopper dredges will not be used in this project.

Smalltooth Sawfish:

This project will have no effect on this species. It is considered extirpated from Texas.

## Part 2

**Explain the actions to reduce adverse effects to critical habitat listed above (For critical habitat for which impacts were identified, describe any conservation measures (e.g. BMPs) that will be implemented to avoid or minimize the impacts. Conservation measures are designed to avoid or minimize effects to listed species and critical habitats or further the recovery of the species under review. Conservation measures are considered part of the proposed action and their implementation is required. Any changes to, modifications of, or failure to implement these conservation measures may result in a need to reinitiate this consultation.)**

There is no critical habitat within the project area.

### Section H. Effect Determination Requested

Attwater's Greater prairie chicken – No Effect

Piping plover – May Affect, Not Likely to Adversely Affect

Red knot – May Affect, Not Likely to Adversely Affect

Sprague's Pipit – May Affect, Not Likely to Adversely Affect

West Indian Manatee – May Affect, Not Likely to Adversely Affect

Green Sea Turtle – May Affect, Not Likely to Adversely Affect

Hawksbill Sea Turtle – May Affect, Not Likely to Adversely Affect

Kemp's Ridley Sea Turtle – May Affect, Not Likely to Adversely Affect

Leatherback Sea Turtle – May Affect, Not Likely to Adversely Affect

Loggerhead Sea Turtle – May Affect, Not Likely to Adversely Affect

Smalltooth Sawfish – No Effect

### Section I. Bald Eagles

There are eagle home ranges or established territories within the rookery island areas. Eagles have been observed at Smith Point during the fall migration Hawk Watch. There are no eagles nesting within 660 feet of Smith Point Island. If Bald Eagles are observed, these conservation measures will be followed:

1. If bald eagle breeding or nesting behaviors are observed or a nest is discovered or known, all activities (e.g., walking, camping, clean-up, use of a UTV, ATV, or boat) should avoid the nest by a minimum of 660 feet. If the nest is protected by a vegetated buffer where there is *no* line of sight to the nest, then the minimum avoidance distance is 330 feet. This avoidance distance shall be maintained from the onset of breeding/courtship behaviors until any eggs have hatched and eaglets have fledged (approximately 6 months).
2. If a similar activity (e.g., driving on a roadway) is closer than 660 feet to a nest, then you may maintain a distance buffer as close to the nest as the existing tolerated activity.
3. If a vegetated buffer is present and there is no line of sight to the nest and a similar activity is closer than 330 feet to a nest, then you may maintain a distance buffer as close to the nest as the existing tolerated activity.
4. In some instances activities conducted within 660 feet of a nest may result in disturbance, particularly for the eagles occupying the Mississippi barrier islands. If an activity appears to cause initial disturbance, the activity shall stop and all individuals and equipment will be moved away until the eagles are no longer displaying disturbance behaviors.

If these measures cannot be implemented, then you must contact the Service's Migratory Bird Permit Office.

Texas – (505) 248-7882 or by email: [permitsR2MB@fws.gov](mailto:permitsR2MB@fws.gov)

## **Section J. Migratory Birds**

While nesting activity of colonial waterbirds has declined in recent years, waterbirds that used the site historically for nesting continue to use Smith Point Island for staging, loafing, roosting, and possible nesting sites (Table 1). The island supports limited colonial waterbird nesting and little species diversity due to changes in vegetation and habitat loss from erosion. The island is used to support development of fledged young until they are able to support themselves in foraging habitats in the Smith Point peninsula vicinity. Non-colonial waterbirds, primarily the American oystercatcher and the eastern willet, may use the existing island for nesting as well. The island is rapidly eroding and there may or may not be nesting habitat present at the time of project implementation. If nesting activities are occurring, then the majority of construction activities will not occur during the nesting season, which is usually February 1 until August 15. However, some field activities that pose minimal disturbance may be acceptable to occur while birds are nesting. Any such activities potentially affecting migratory birds would be coordinated with the appropriate state and federal agency biologists and with non-governmental organization (NGO) partners prior to initiation of the field work.

For non-breeding migratory birds the island currently supports roosting and limited foraging use. The different bird taxonomic guilds and use activities are listed below:

Loons and Grebes – This group of birds may use surrounding waters during the fall, winter, and spring to forage. Presence in the area would be based on available forage fish and invertebrates. Construction activities may cause the birds to move out of nearby foraging areas, however, not take is anticipated.

Waterfowl – Waterfowl use of the island is limited. Surrounding bay waters are used by several species of wintering waterfowl, primarily bay ducks. This group may be affected by construction activities. The temporary nature of construction and this bird group's use of more undisturbed waters will avoid take.

Pelicans and Cormorants – These will use the existing island for resting, staging and or roosting during the fall, winter and spring. Construction activities will cause the birds using the island to move to other nearby sites. Acclimation to construction activities may take place.

Wading Birds – These heron and egret species may use the existing island to some degree for resting and may use the shallow intertidal zone to feed. This use would be limited.

Terns and Gulls – These species will use the island site for resting, staging and or roosting. Foraging areas would constantly change depending on the presence of forage fish, currents, etc. and thus may or may not be proximal to the site. These birds will move to other nearby sites in the bay system to use for these purposes.

Shorebirds – Significant numbers of shorebirds migrate through the Texas coast in the fall and spring and these may use the intertidal zone to forage. Several species overwinter as well and may use the intertidal areas of the existing island to forage. Construction activities may limit the use of the island by these birds. There are other sites nearby that would serve similar uses.

Construction activities would occur between August 15 and February 1. These activities would avoid nesting season. The disruptions caused by construction activities during this period would be temporary and once completed the restored island would provide a greater range of habitats available for birds to use. Increased vegetation would improve habitats that are essential for nesting colonial waterbirds and provide a long-term benefit. Other sites are available nearby that support loafing and roosting birds. The proposed actions would support the project goal to increase the number of nesting pairs of colonial waterbirds. The proposed actions would also provide more opportunity for many of the above listed bird groups as well as other guilds during the non-nesting season.

**Pre-existing NEPA Documents?**

Yes

**If tiered from a programmatic EIS or EA, then provide the programmatic document or a link below.**

Tiered from the DWH ER Phase III ERP/PEIS which can be found at:

DRAFT/DELIBERATIVE; ATTORNEY WORK PRODUCT; ATTORNEY CLIENT COMMUNICATION; PRIVILEGED AND/OR CONFIDENTIAL

<http://www.gulfspillrestoration.noaa.gov/restoration/early-restoration/phase-iii/>

**Name of Person Completing this Form:** Angela Schrift

**Name of Project Lead:**

**Date Form Completed:** 4/2/2015

**Date Form Updated:** 6/30/2015



## References

- Audubon Texas. 2014. Draft Texas Colonial Waterbird Rookery Island Conservation Plan.
- U.S. EPA. 2007. National Estuary Program Coastal Condition Report. Report No. EPA-842/B-06/001 2006. Pgs 288-301.  
[http://water.epa.gov/type/oceb/nep/upload/2007\\_05\\_09\\_oceans\\_nepccr\\_pdf\\_nepccr\\_nepccr\\_gom\\_partg.pdf](http://water.epa.gov/type/oceb/nep/upload/2007_05_09_oceans_nepccr_pdf_nepccr_nepccr_gom_partg.pdf)
- Galveston Bay Estuary Program (GBEP). 1995. The Galveston Bay Plan: The Comprehensive Conservation and Management Plan for the Galveston Bay Ecosystem. Publication No. GBNEP-49. October.  
<http://gbic.tamug.edu/GBPlan/sections/PrePages.pdf>
- Galveston Bay Foundation. 1998. Galveston Bay Habitat Conservation Blueprint: A Plan to Restore the Habitats and Heritage of Galveston Bay. <http://gbic.tamug.edu/hcb/hab.htm> Accessed April 2, 2015. GBEP. 2009. Charting the Course to 2015: Galveston Bay Strategic Action Plan.  
<https://www.tceq.texas.gov/publications/gi/gi-385.html>
- Gulf Coast Joint Venture. 2012. Texas Mid-Coast Initiative Area Fact Sheet.  
[http://www.gciv.org/docs/Texas\\_Mid\\_Coast\\_IA\\_fact\\_sheet\\_Final\\_6\\_18\\_12.pdf](http://www.gciv.org/docs/Texas_Mid_Coast_IA_fact_sheet_Final_6_18_12.pdf)
- Kushlan, J.A., M.J. Steinkamp, K.C. Parsons, J. Capp, M.A. Cruz, M. Coulter Davidson, L. Dickson, N. Edelson, R. Elliot, R.M. Erwin, S. Hatch, S. Kress, R. Milko, S. Miller, K. Mills, R. Paul, R. Phillips, J.E. Saliva, B. Syderman, J.L. Trapp, J. Wheeler, K. Wohl. 2002. Waterbird Conservation for the Americas: The North American Waterbird Conservation Plan, Version 1, I.J. Washington, D.C. 78pp.
- National Oceanic and Atmospheric Administration (NOAA). 2012. Measures for Reducing Entrapment Risk to Protected Species.  
[http://sero.nmfs.noaa.gov/protected\\_resources/section\\_7/guidance\\_docs/documents/entrapment\\_bmps\\_final.pdf](http://sero.nmfs.noaa.gov/protected_resources/section_7/guidance_docs/documents/entrapment_bmps_final.pdf)
- NOAA. 2007. Revision 2 to the National Marine Fisheries Service (NMFS) November, 19, 2003, Gulf of Mexico Regional Biological Opinion (GRBO) to the U.S. Army Corps of Engineers (COE) on Hopper Dredging of Navigation Channels and Borrow Areas in the U.S. Gulf of Mexico.
- Texas Parks and Wildlife Department (TPWD). 2012. Texas Conservation Action Plan 2012 – 2016: Gulf Coast Prairies and Marshes Handbook. Editor, W. Connally, Texas Conservation Action Plan Coordinator. Austin, Texas.  
[https://tpwd.texas.gov/landwater/land/tcap/documents/gcpm\\_tcap\\_2012.pdf](https://tpwd.texas.gov/landwater/land/tcap/documents/gcpm_tcap_2012.pdf)
- Wilson, T. E., J. Wheeler, M. C. Green, and E. Palacios. (eds.). 2014. Reddish Egret Conservation Action Plan. Reddish Egret Conservation Planning Workshop, October 2012. Corpus Christi, TX.  
[http://www.reddishegret.org/REEG\\_plan\\_final\\_single.pdf](http://www.reddishegret.org/REEG_plan_final_single.pdf)

DRAFT/DELIBERATIVE; ATTORNEY WORK PRODUCT; ATTORNEY CLIENT COMMUNICATION; PRIVILEGED AND/OR CONFIDENTIAL

U.S. Fish and Wildlife Service (USFWS). 2006. Strategic Plan: The Coastal Program Stewardship of Fish and Wildlife Through Voluntary Conservation. Regional Step-Down Plan Region 2 (Texas) Part 2 of 3 FY 2006-2010. <http://www.fws.gov/coastal/strategicPlan.html>.

USFWS and North Carolina Audubon Society. 2006. Southeast United States Regional Waterbird Conservation Plan. Compiled by: W.C. Hunter (USFWS Region 4), W. Golder (North Carolina Audubon Society), S. Melvin (USFWS Region 4), and J. Wheeler (USFWS Region 9). September. <http://www.waterbirdconservation.org/pdfs/regional/seusplanfinal906.pdf>

Vermillion, W.G., and B.C. Wilson. 2009. Gulf Coast Joint Venture Conservation Planning for Reddish Egret. Gulf Coast Joint Venture, Lafayette, LA. 18pp. <http://www.gciv.org/documents.php>.



Figure 1. Location of proposed rookery island restoration and protection projects in Texas.

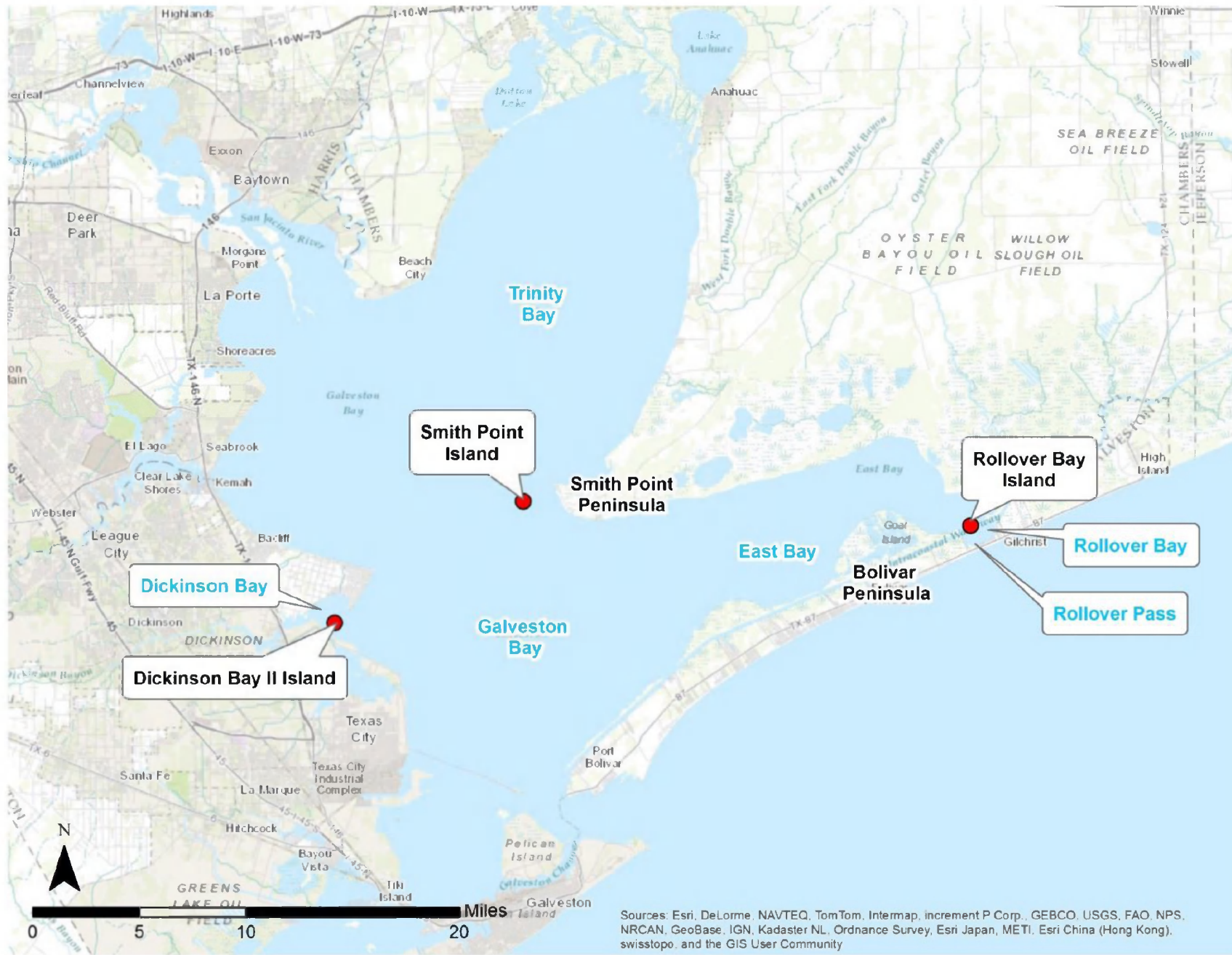

Figure 2. Location of proposed rookery island restoration and protection projects in Galveston Bay.

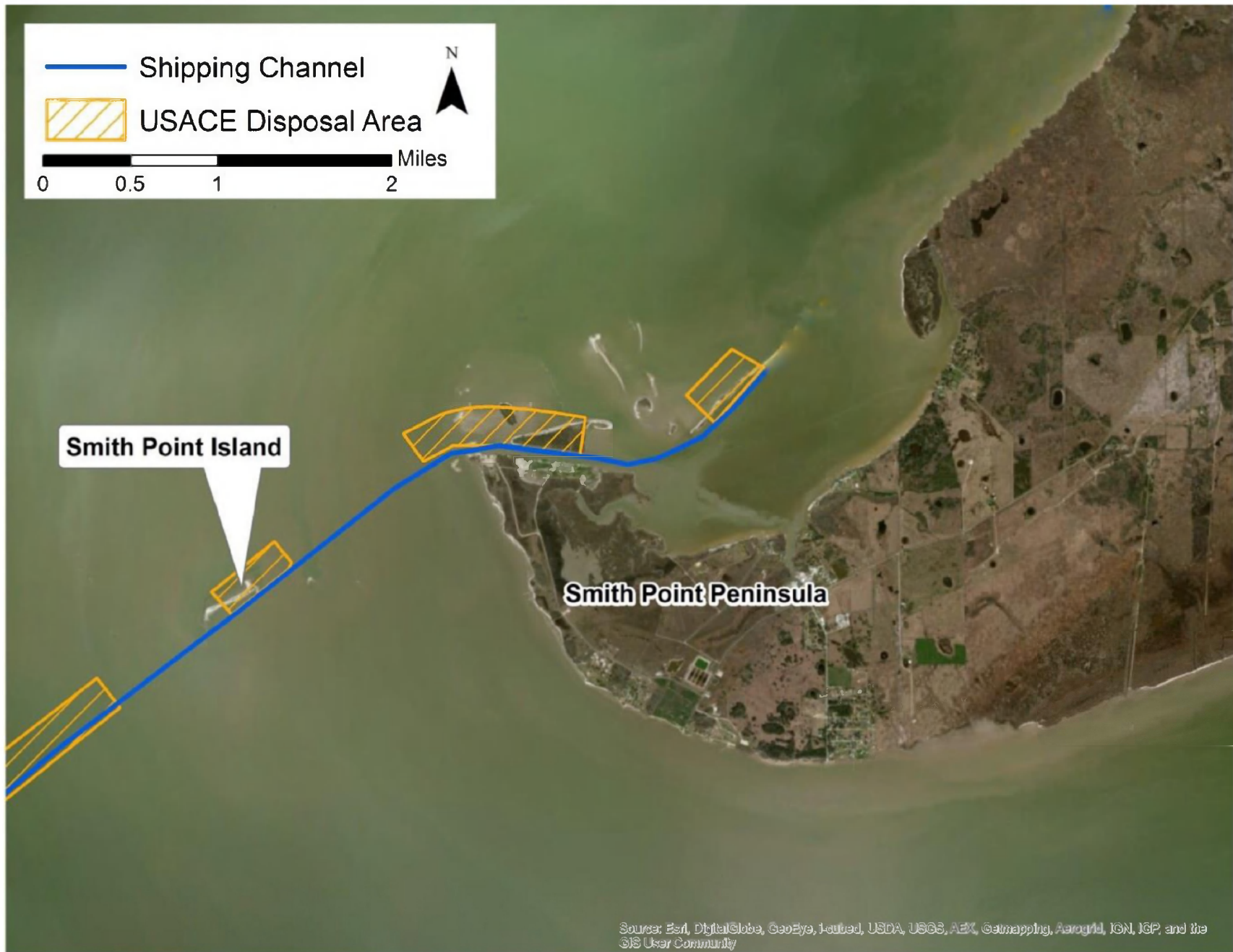

Figure 3. Location of Smith Point Island and nearby Smith Point Peninsula in Galveston Bay.



Figure 4. Smith Point Island as of 2014 showing existing breakwater feature. Aerial photograph is from 2011.



Figure 5. Proposed restoration and protection features for Smith Point Island showing access channel and describing openings in breakwater associated with interior lagoons to allow ingress and egress of tidal waters.

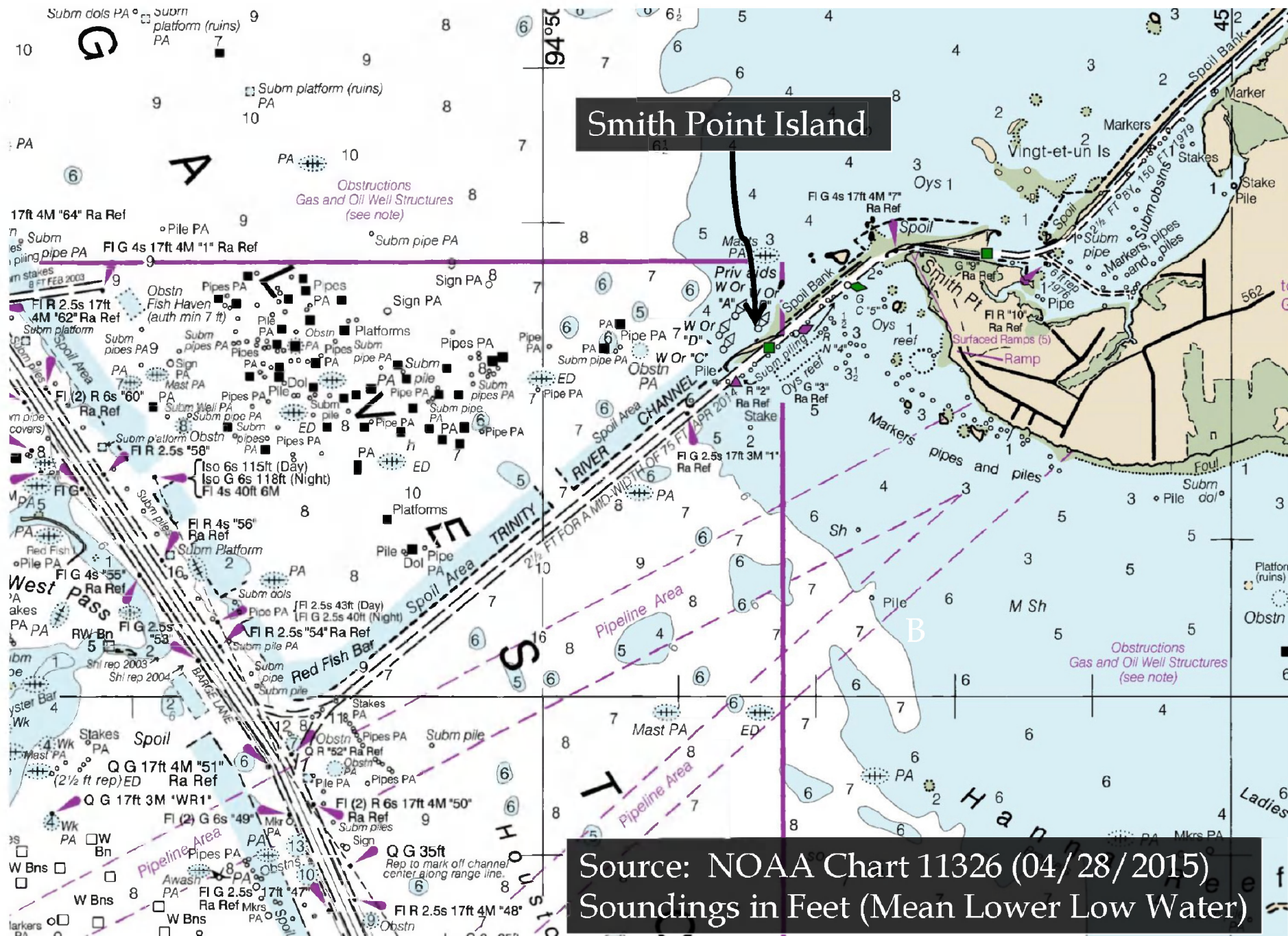

Figure 6. Smith Point Island Action Area



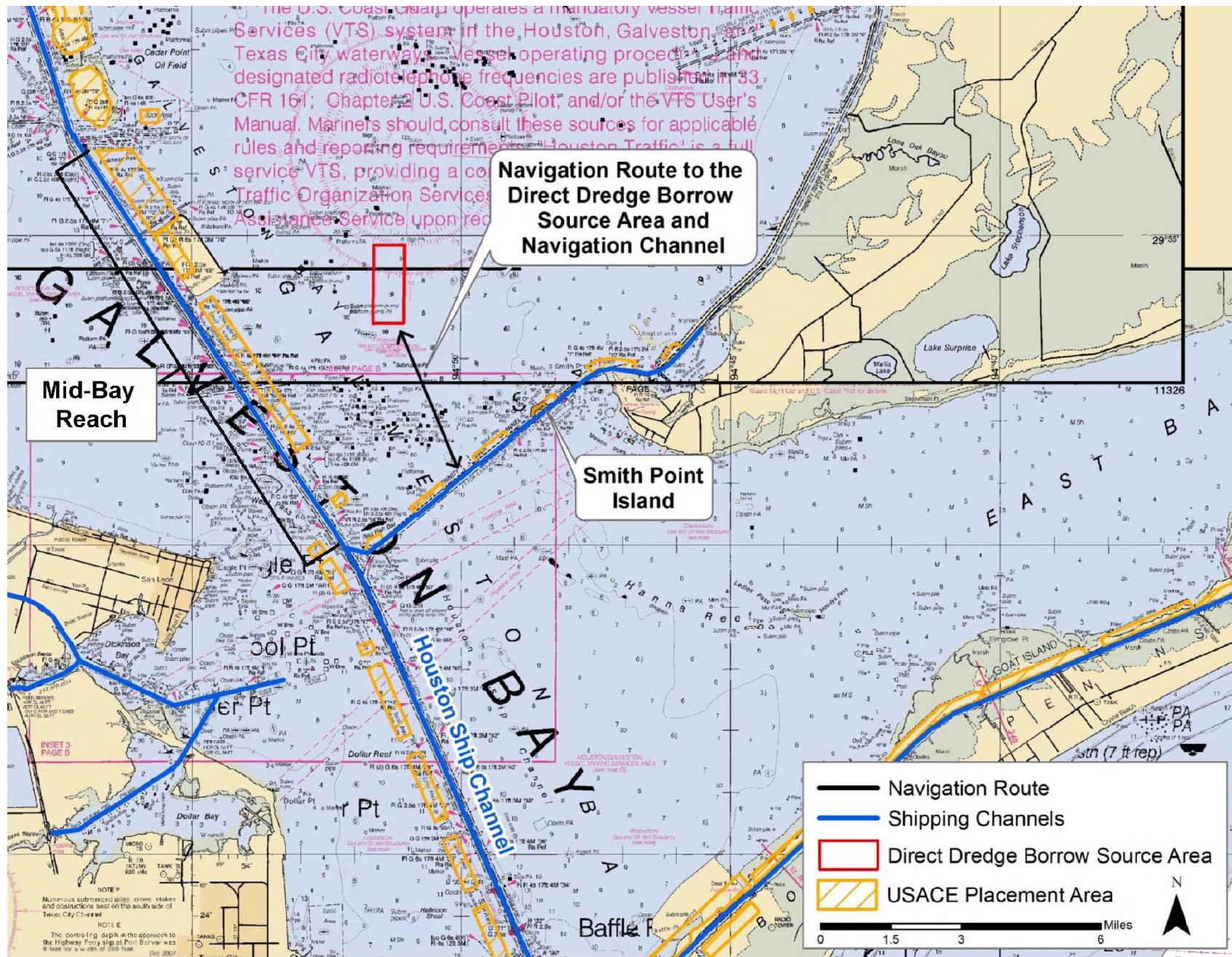

Figure 7. Proposed project in relation to existing navigation channels and routes for transport of material. The Mid-Bay Reach of the Houston Ship Channel identified as a potential source of material.

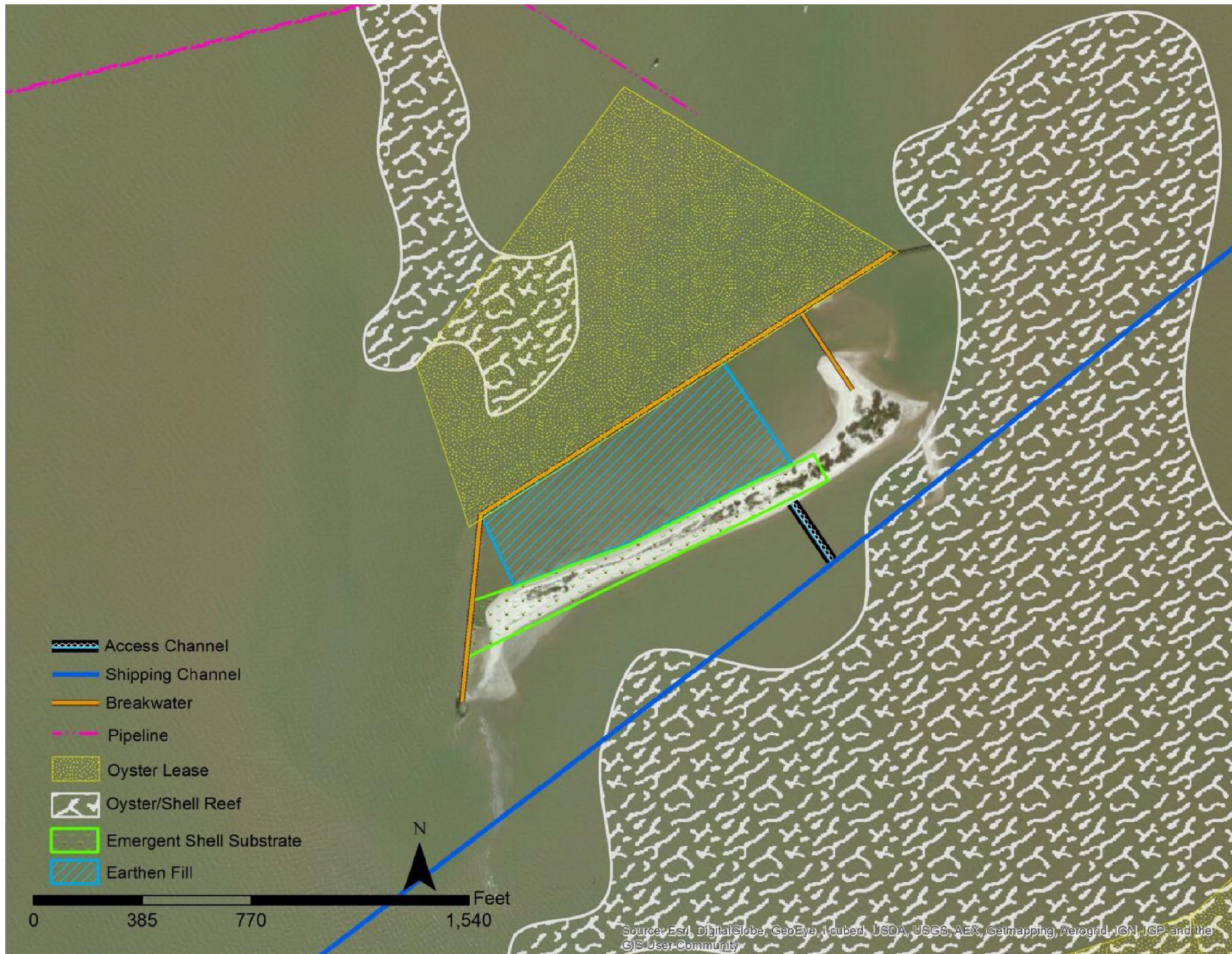

Figure 8. Proposed project in relation to existing shipping channel, oyster reef, oyster leases, and pipelines.

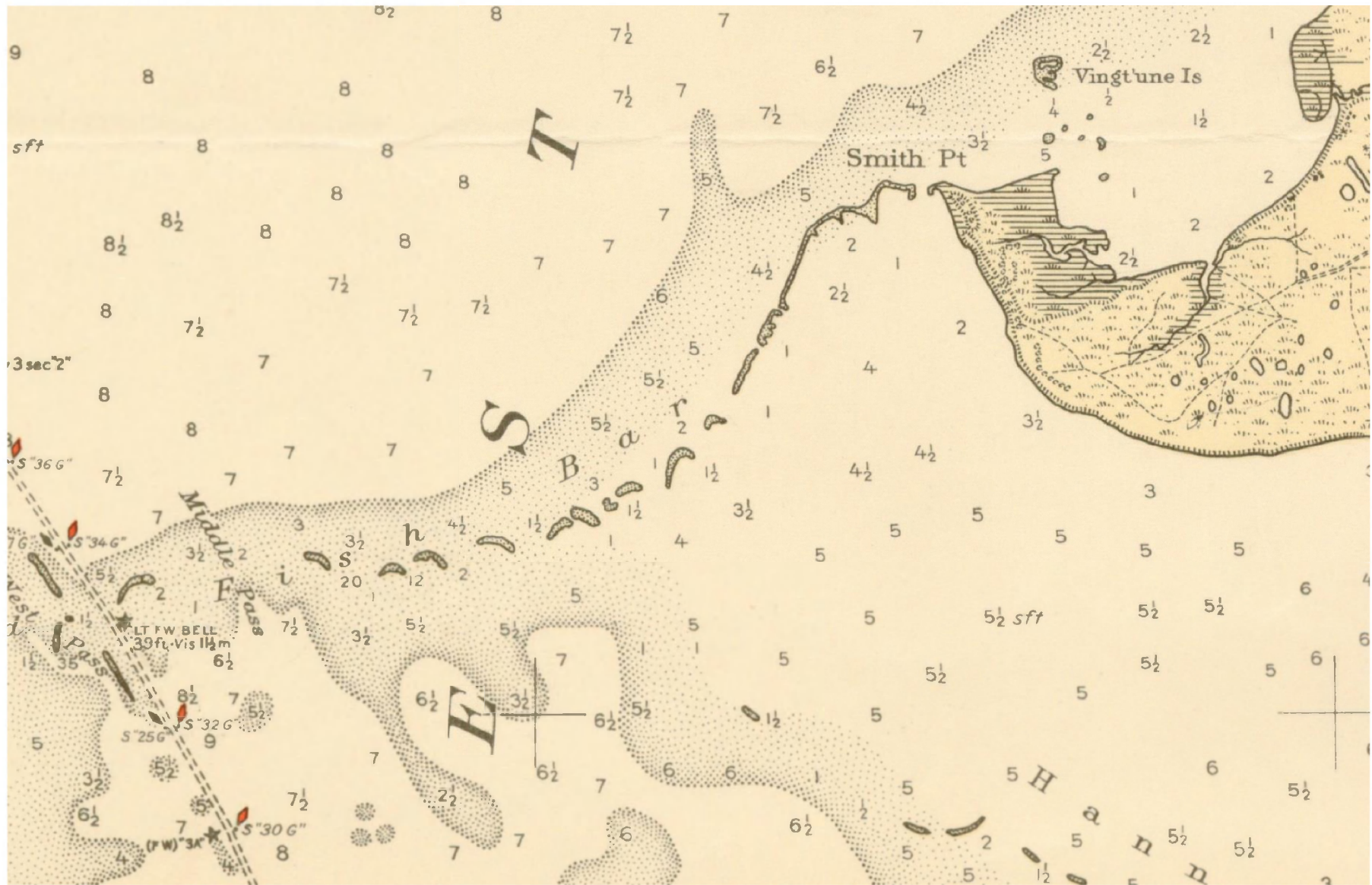

Figure 9. NOAA map of Smith Point in 1921.

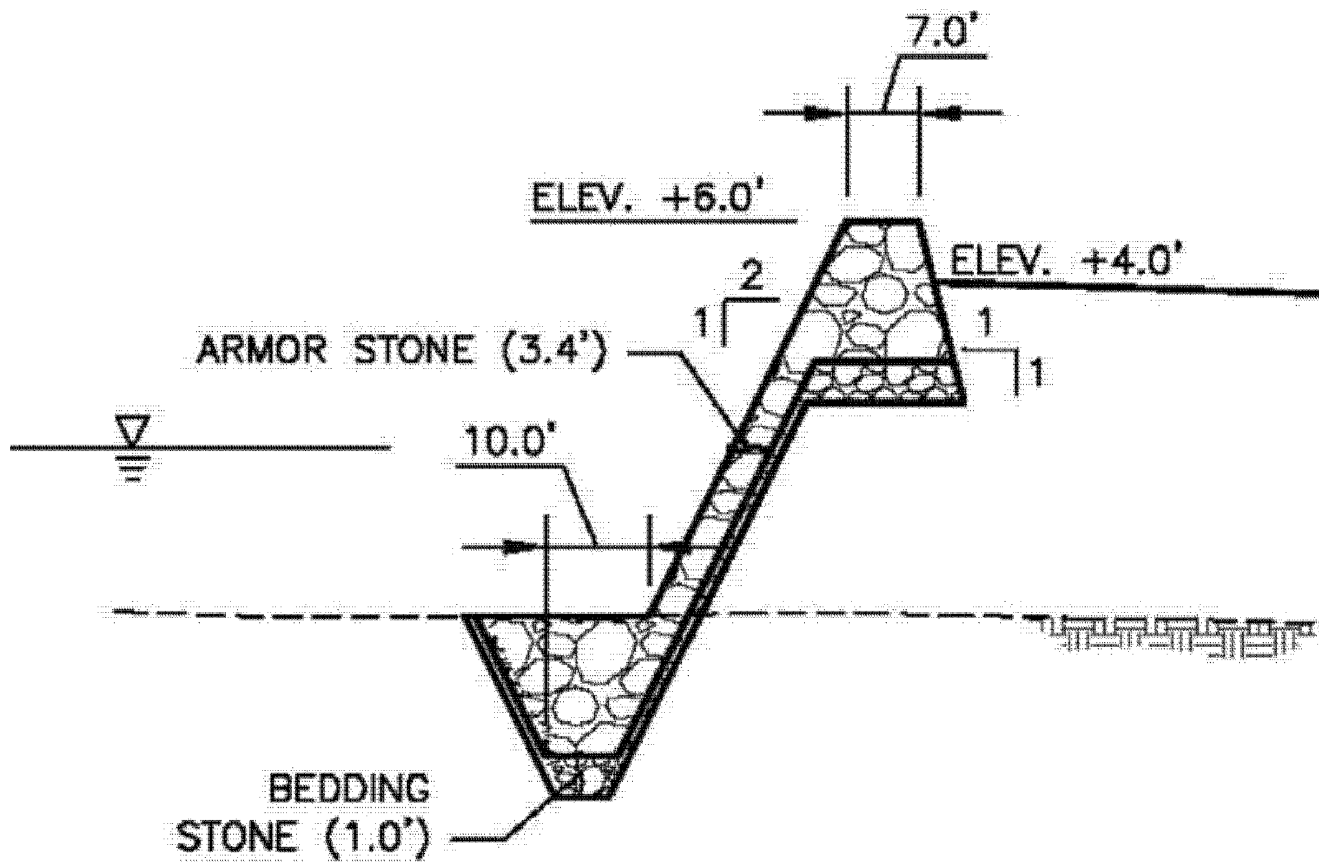

Figure 10. Typical shoreline armoring design (HDR 2014).

# Attwater's greater prairie-chicken

*Tympanuchus cupido attwateri*

B000

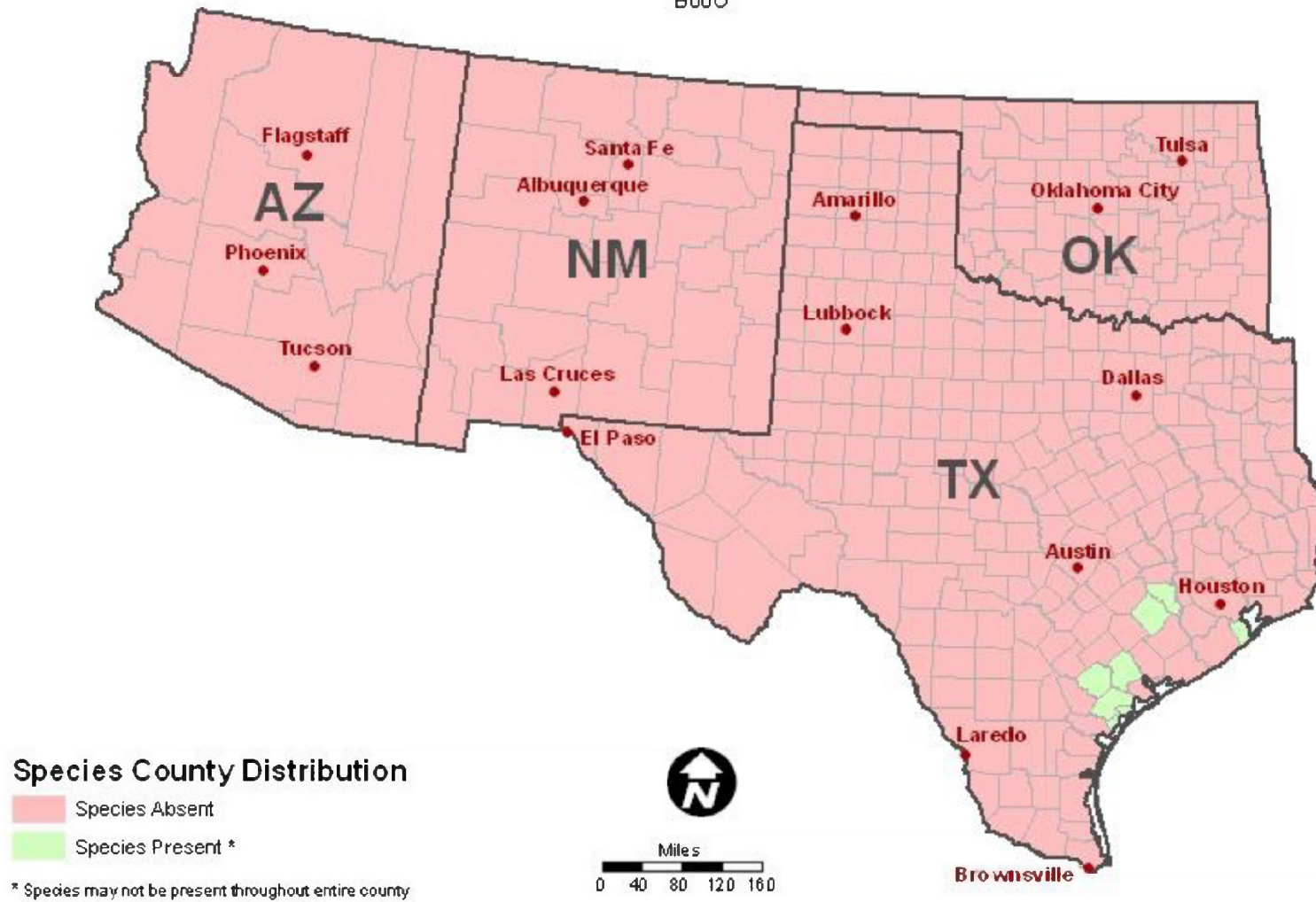

Figure 11. Location map of the county distribution of Attwater's greater prairie-chicken. Map was created by USFWS.

# piping plover

*Charadrius melodus*

B079

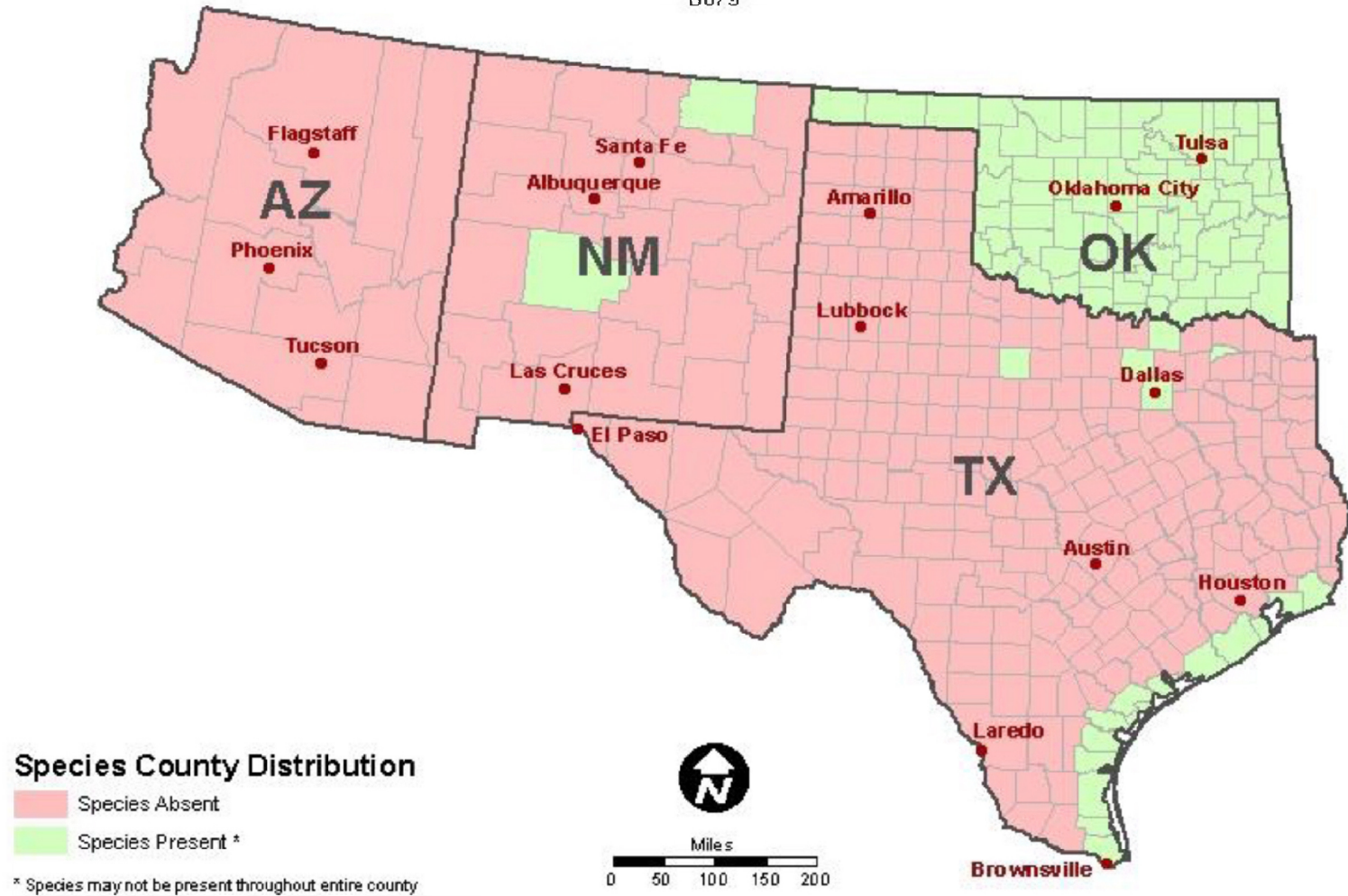

Figure 12. Location map of the county distribution of piping plover. Map was created by USFWS.

# red knot

*Calidris canutus rufa*

BODM

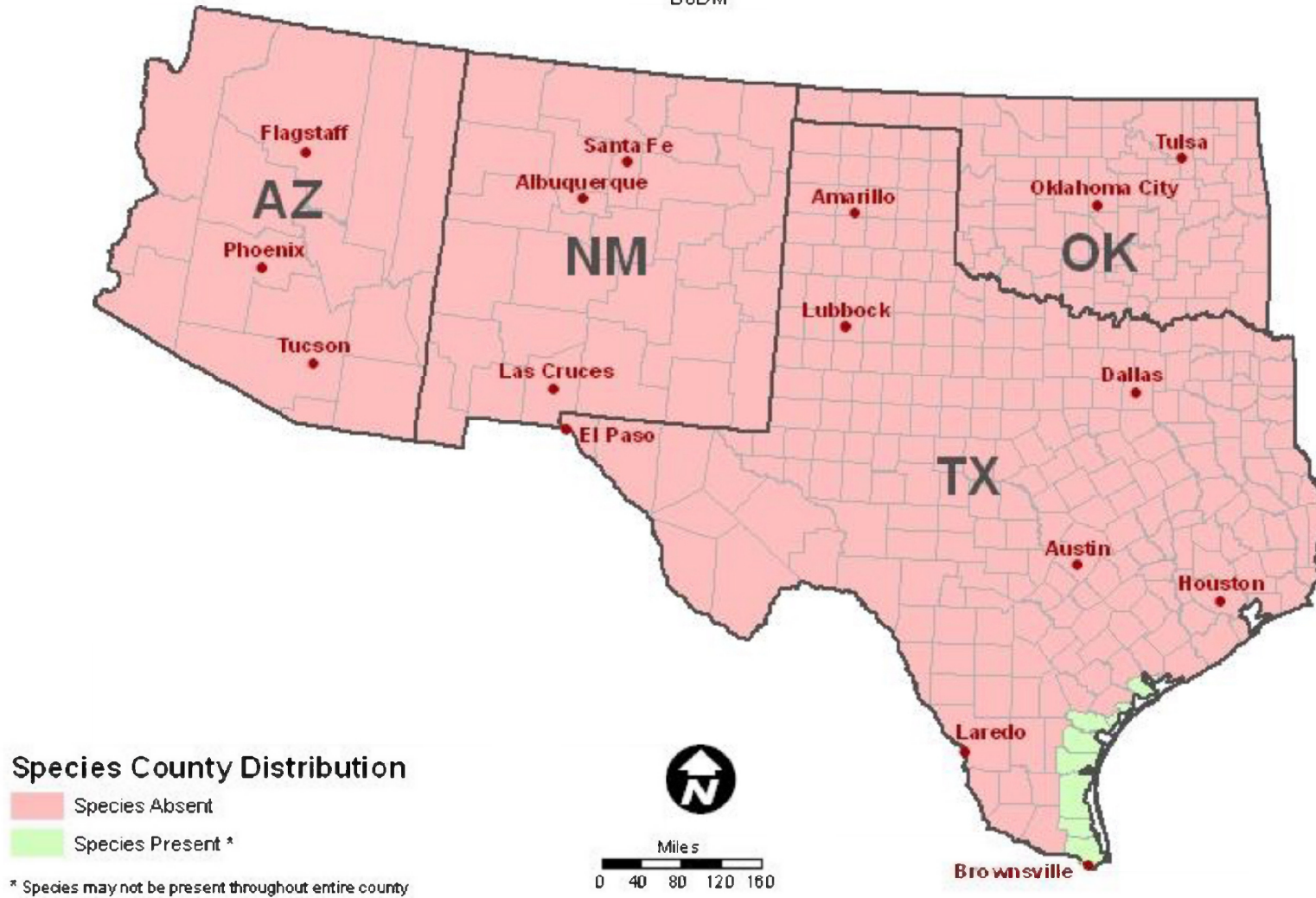

Figure 13. In contrast to the USFWS map showing red knot distribution, red knots have been found to occur in Galveston County (<http://ebird.org/ebird/map/>).

# Sprague's pipit

*Anthus spragueii*

B0GD

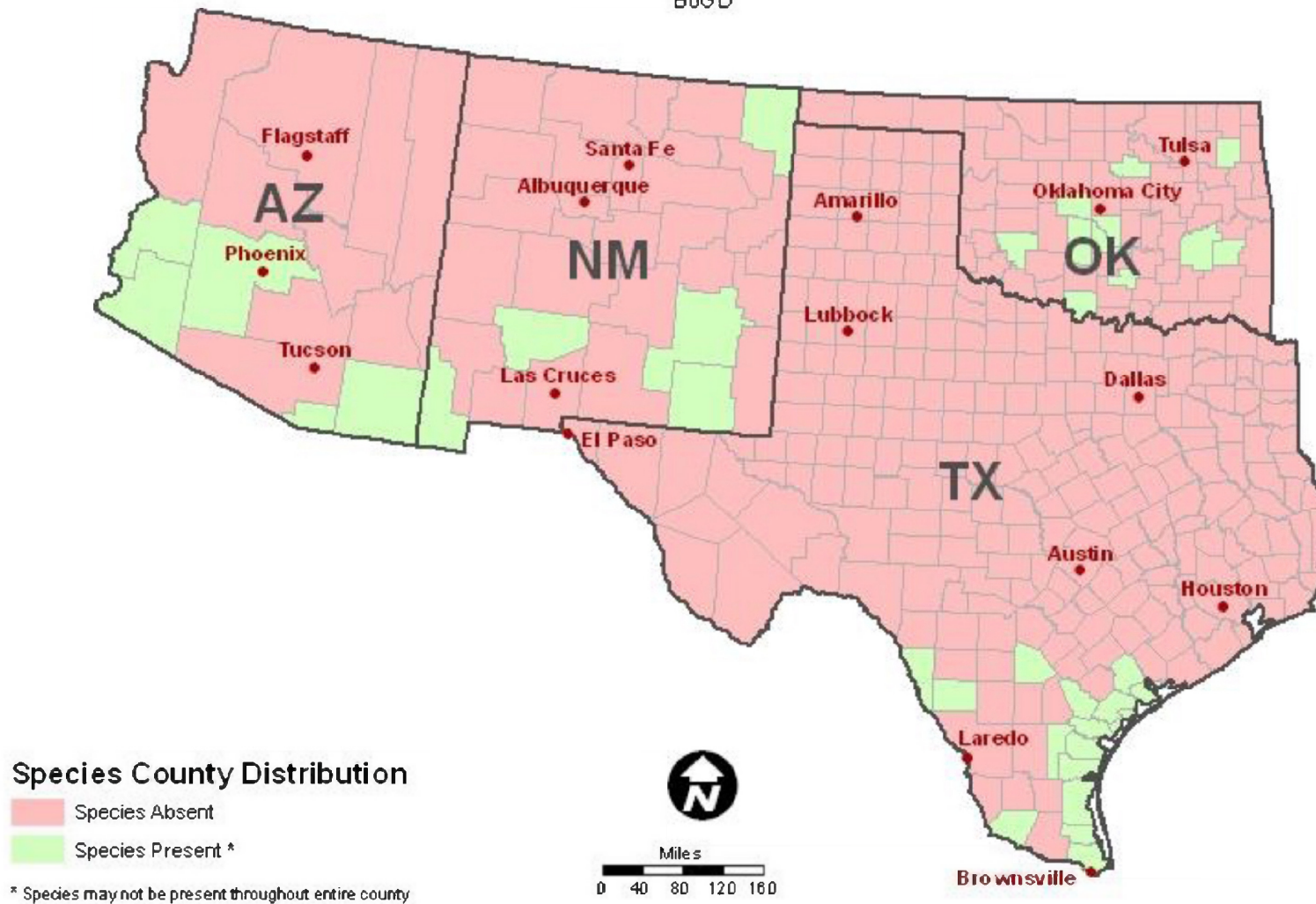

Figure 14. In contrast to the USFWS map showing Sprague's pipit distribution, Sprague's pipits have been found to occur in Galveston County (<http://ebird.org/ebird/map/>).



# West Indian manatee

*Trichechus manatus*

A007

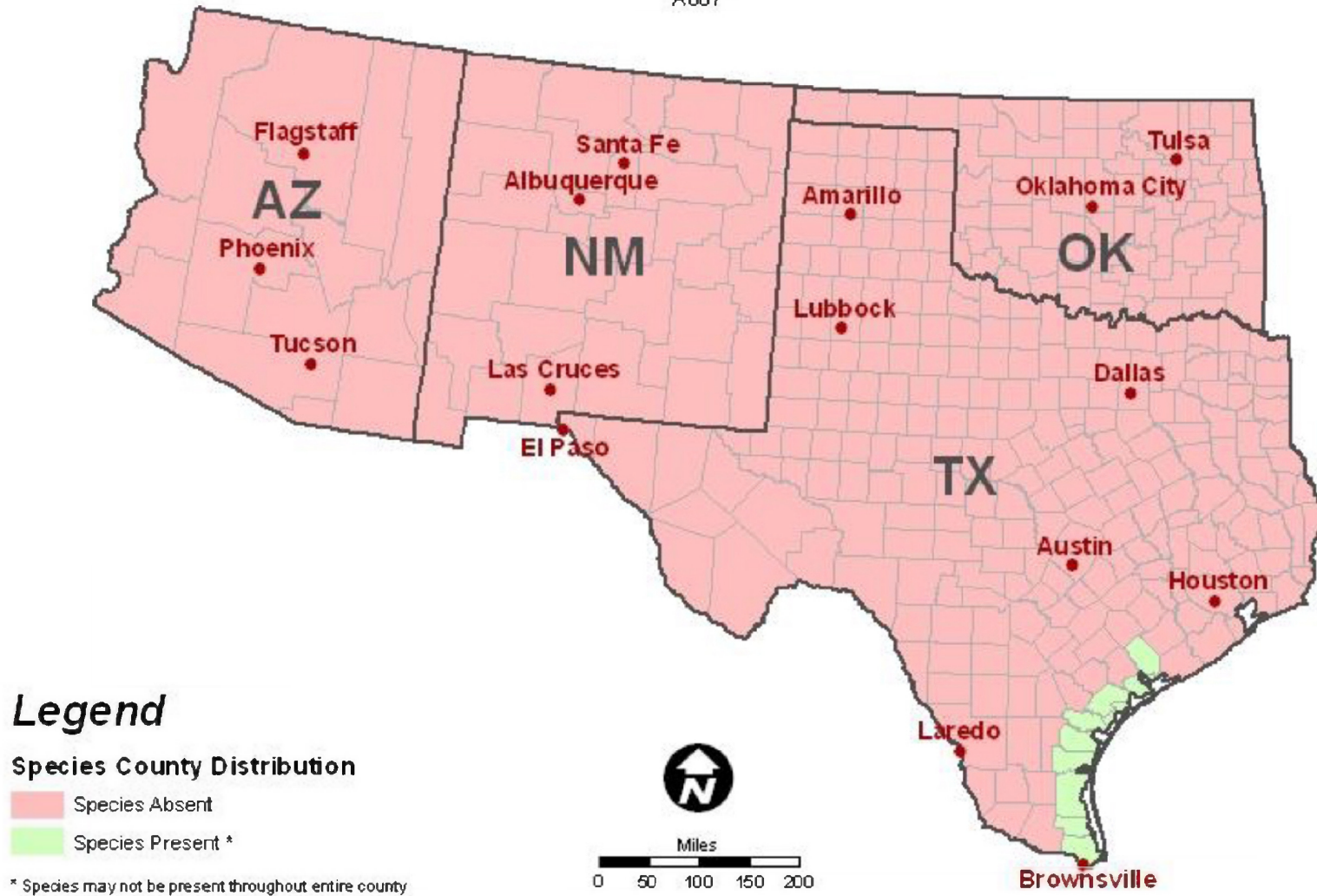

Figure 15. Despite the USFWS map showing the West Indian manatee distribution, on rare occasions they have been sighted in Galveston Bay.

# green sea turtle

*Chelonia mydas*

C00S

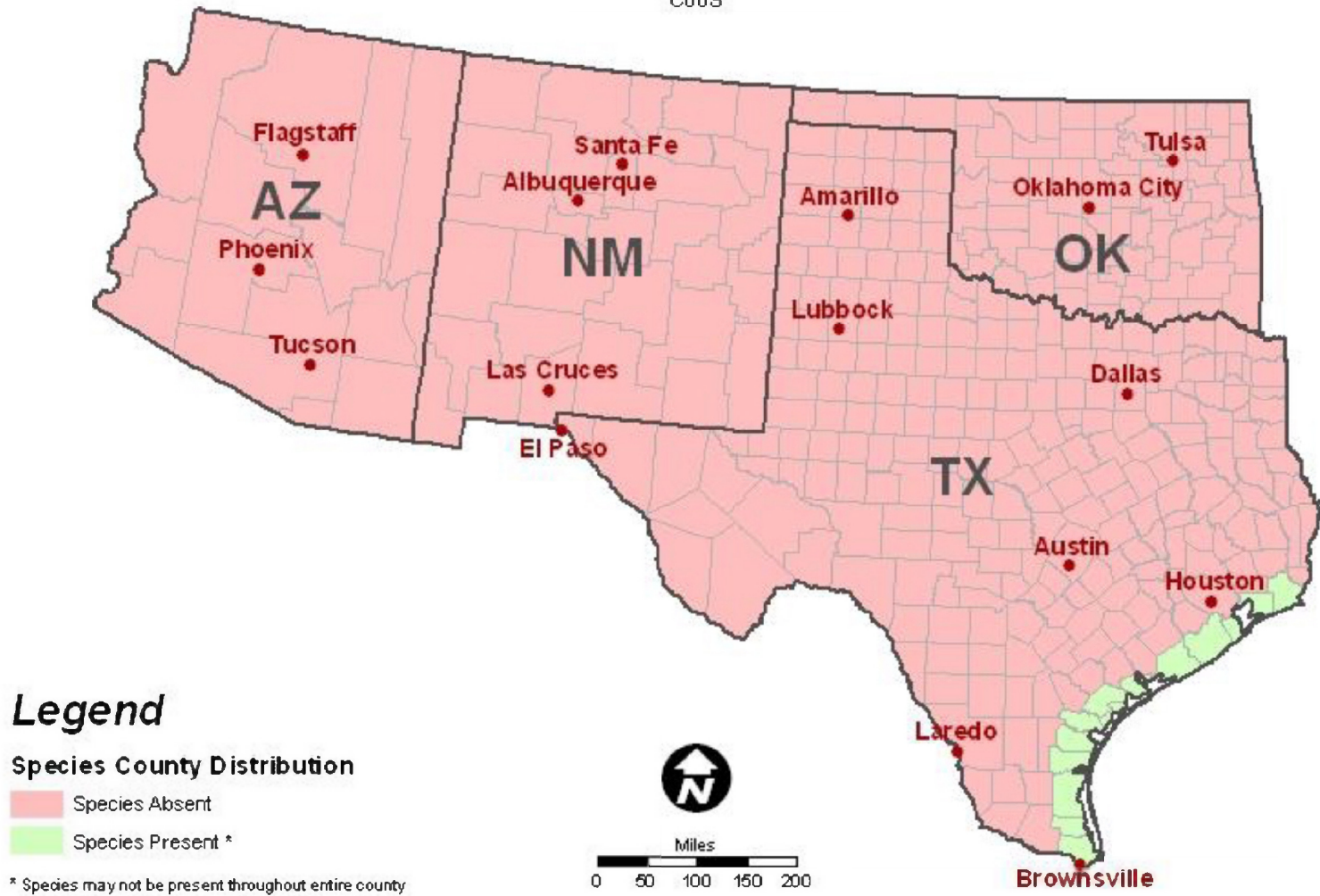

Figure 16. Location map of the county distribution of green sea turtle. Map was created by USFWS.

# hawksbill sea turtle

*Eretmochelys imbricata*

C00E

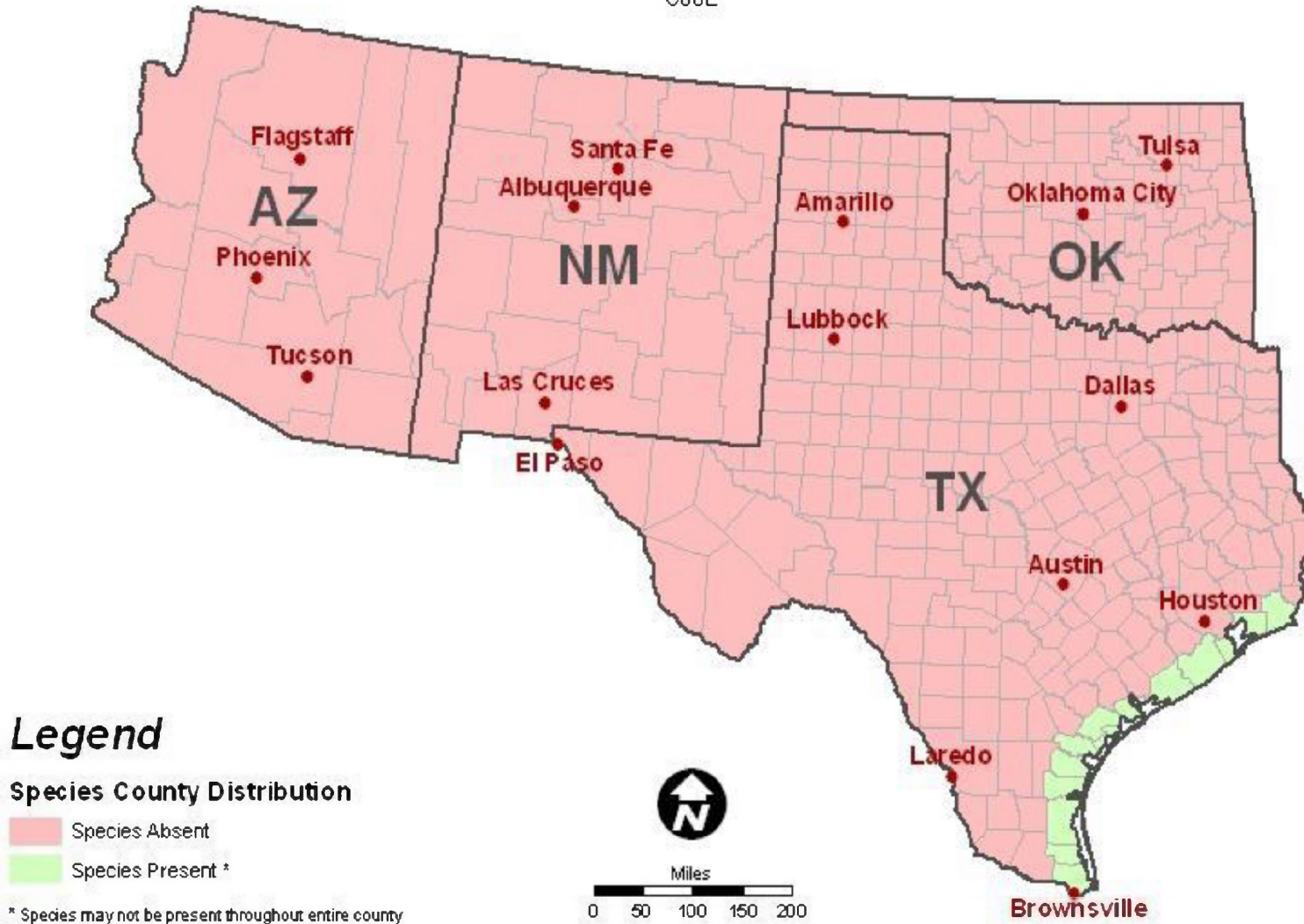

Figure 17. Location map of the county distribution of hawksbill sea turtle. Map was created by USFWS.

# Kemp's Ridley sea turtle

*Lepidochelys kempii*

C000

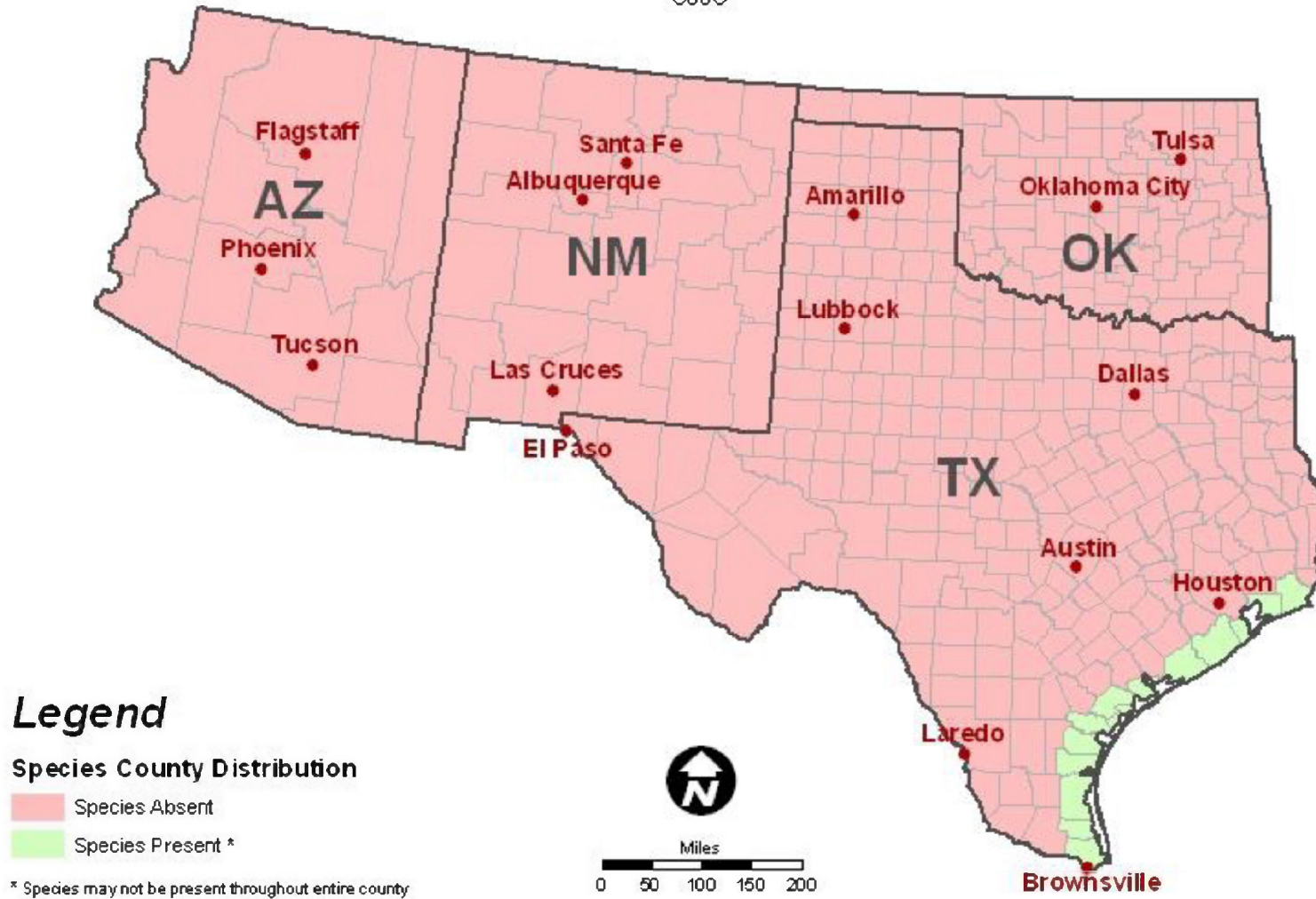

Figure 18. Location map of the county distribution of Kemp's ridley sea turtle. Map was created by USFWS.

# leatherback sea turtle

*Dermochelys coriacea*

COOF

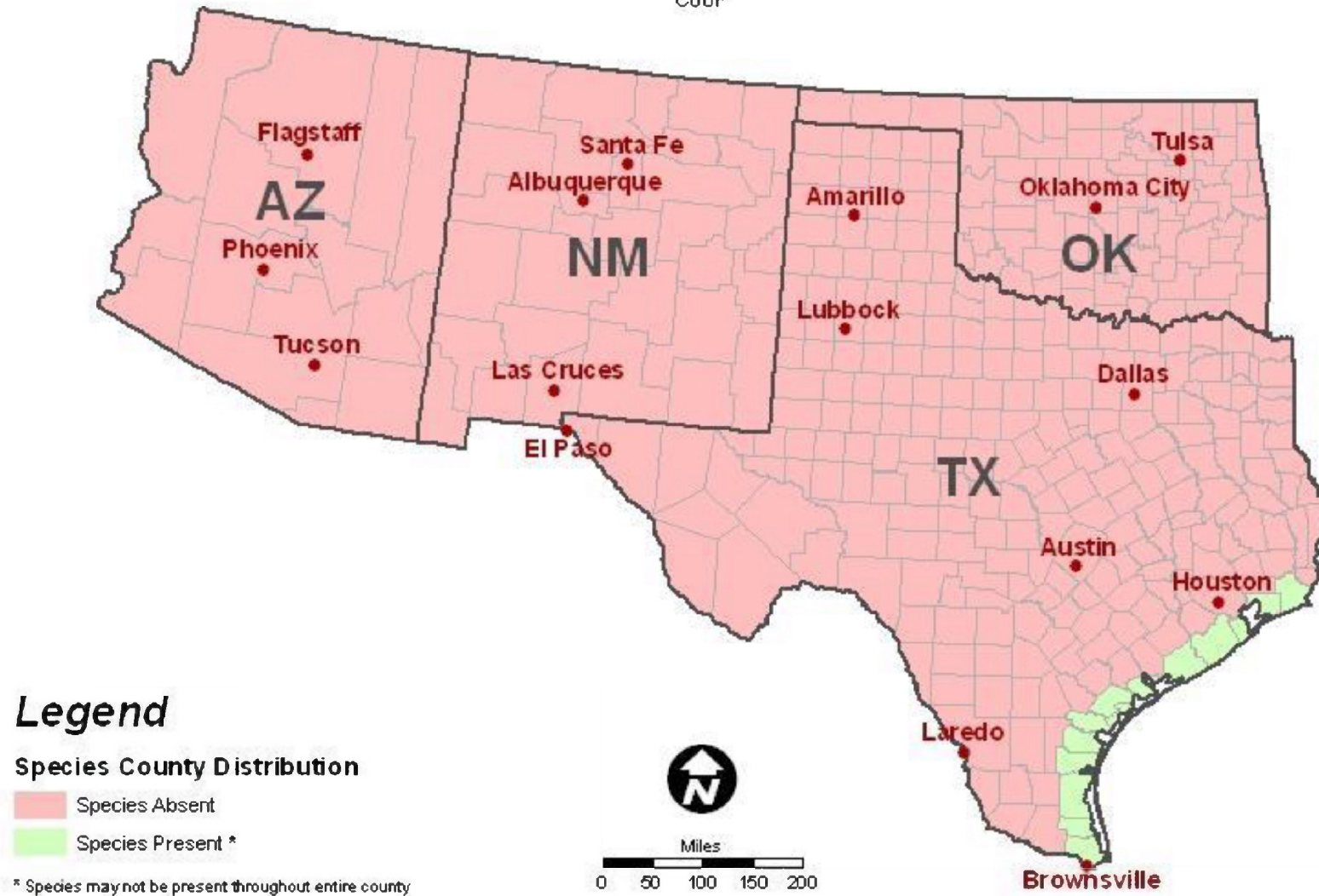

Figure 19. Location map of the county distribution of leatherback sea turtle. Map was created by USFWS.

# loggerhead sea turtle

*Caretta caretta*

C00U

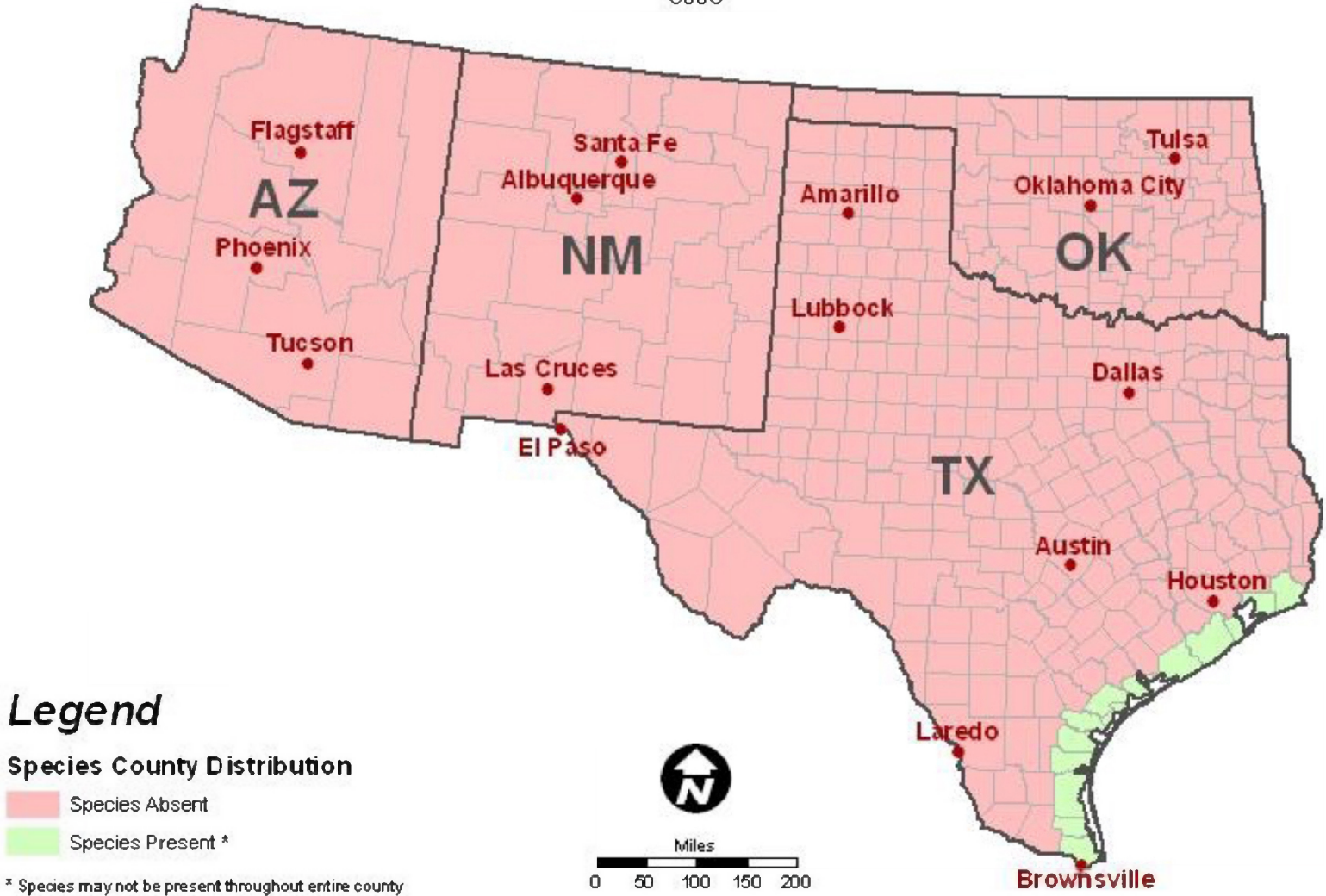

Figure 20. Location map of the county distribution of loggerhead sea turtle. Map was created by USFWS.